



# NYK Group Decarbonization Story

Decarbonization Group  
ESG Strategy Headquarters, NYK Line

November 2023



## Chapter

---

01. Purpose and Logbook the Journey

02. Decarbonization Strategy

- 1 GHG Reduction and Removal Plan
- 2 Concept for Sustainable Growth

Appendix

## 01.

Purpose and Logbook of the Journey

## 02.

Decarbonization Strategy

### 02-1

GHG Reduction and Removal Plan

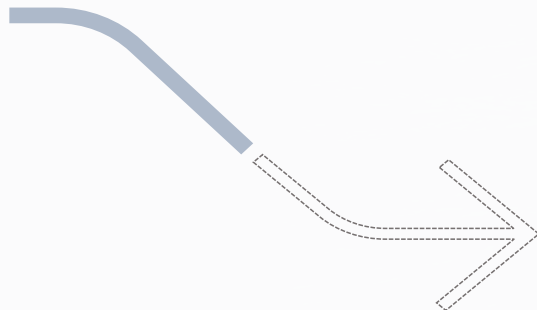

Mitigate Climate Impact

### 02-2

Concept  
for Sustainable Growth

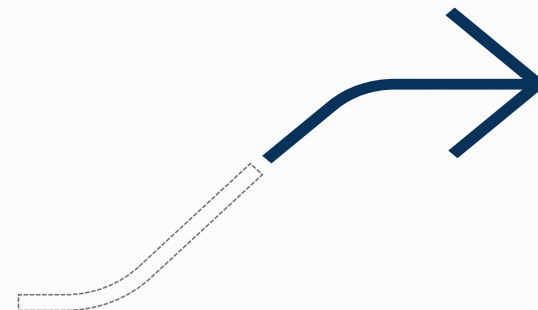

Facilitate Business Development



Chapter 01

---

# Purpose and Logbook of the Journey

## *Purpose*

*We are all navigating in a sea of uncertainty.*

*The goals of this story are as follows:*

- 1. Set a course for decarbonization*
- 2. Encourage reader's participation and engagement*
- 3. Realize sustainable growth through the journey*

*Standing at a critical moment for humanity in the global warming crisis,  
our stakeholders are concerned about our business resilience and  
our capability to cope with the climate agenda.*

*In response we are showing the world our bold vision and concrete actions as  
a part of a strategy to walk a climate-positive path together with likeminded  
partners united by a shared ambition.*

*A will finds a way.*

*This is the NYK Group Decarbonization Story.*

*Let all lines go and set sail for a decarbonized future.  
Our journey has already started.*

# History of the NYK Group's environmental agenda



✔ Our journey thus far shows that our **“passion for planetary wellbeing”** is on solid ground to continuous actions against climate change, enabling us to stay one step ahead to lead the industry.

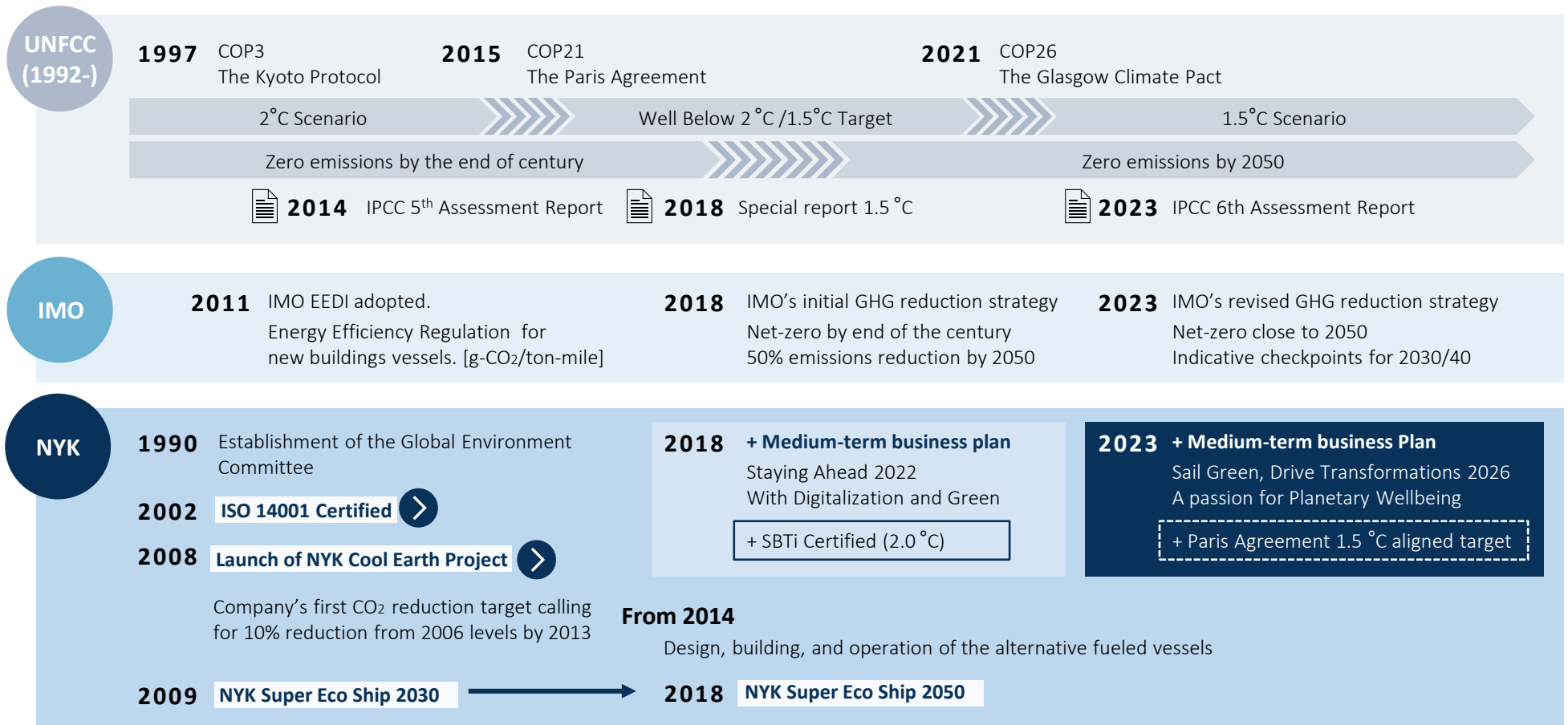

IMO: International Maritime Organization, EEDI: Energy Efficiency Design Index, SBTi: Science Based Targets initiatives, CS: Cross-sector

# A Passion for a zero-emission ship (1/3)



- ✔ In 2009, NYK designed **NYK Super Eco Ship 2030** as a concept ship to mark the midpoint of the journey toward zero emissions by 2050.
  - Ships are the most environmentally friendly mode of transportation, but as the global economy develops and trade increases, the number of ships in the world also increases, leading to concerns about an increase in GHG emissions.
  - In order for ships to continue to be environmentally friendly means of transportation that can contribute to the development of the global economy, the NYK Group has envisioned what ships will look like in 2030 and has been developing technology toward that vision.

## NYK Super Eco Ship 2030

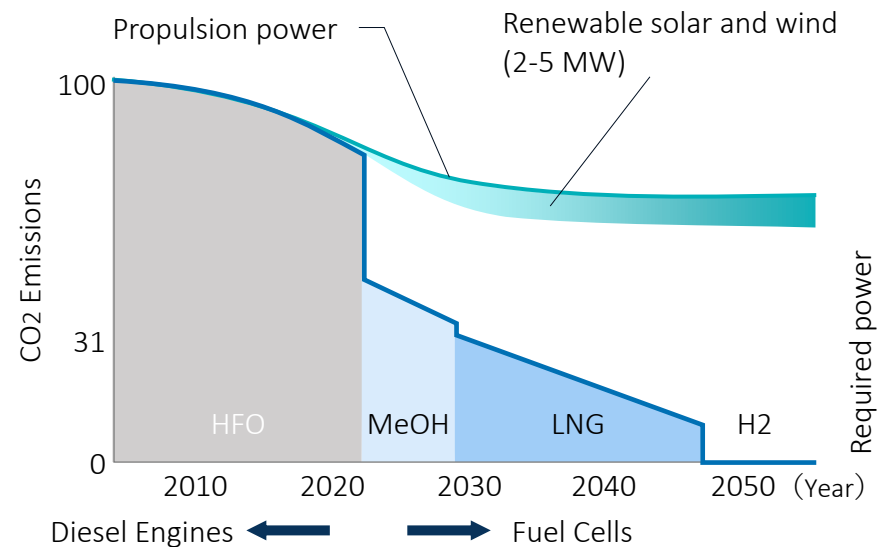



# A Passion for a zero-emission ship (2/3)



- ✔ In 2018, the NYK Group unveiled a new future concept ship: **NYK SUPER ECO SHIP 2050**, which incorporates innovative technologies that will result in an emission-free vessel by 2050.

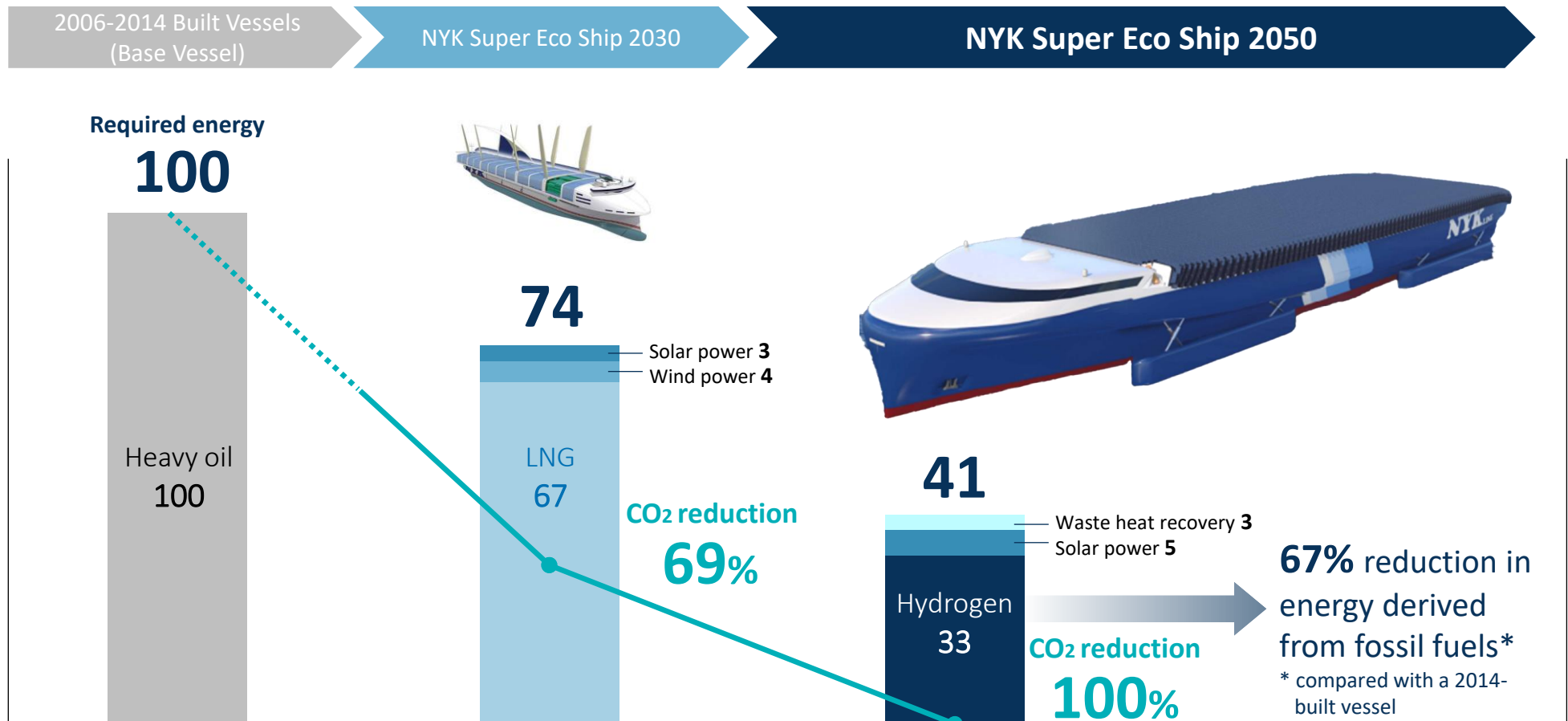

More slides on NYK Super Eco Ship 2050 are in Appendix

## A Passion for a zero-emission ship (3/3)



- NYK has taken a **first-mover advantage** by becoming a leader in concept design, technical management of newbuilds, operation, and maintenance of oceangoing vessels powered by alternative fuels.

Alternative Fuel	LCV (MJ/kg)	Density (ton/m <sup>3</sup> )	Conceptual Design	First Ship Delivery Ship Type, Year, Ship Name, Builder	No. of Ships in 2030* <sup>1</sup>
LNG (about 1.9)	50.0	0.420	2009 NYK SES 2030	<b>Tug:</b> 2015, Sakigake, Keihin Dock Co., Ltd. <b>LNG Bunkering Vessel:</b> 2017, Green Zeebrugge* <sup>2</sup> , Hanjin Heavy Industry <b>Car Carrier:</b> 2016, Auto Eco, KHI/NACKS 2020, Sakura Leader, Shin Kurushima Dockyard <b>Bulk Carrier:</b> 2023, Shoyo, Oshima Shipyard	40 vessels
LPG	46.0	0.448	N/A	<b>VLGC:</b> 2022, Lupinus Planet, KHI	8 vessels
Methanol	19.9	0.796	2009 NYK SES 2030	<b>MR Product Tanker:</b> 2019, Takaroa Sun, Hyundai Mipo Dockyard	3 vessels
Ammonia	18.8	0.674	2022 AFAGC, ABV (AiP awarded)	<b>Tug:</b> 2024, TBA, Keihin Dock (Conversion) <b>AGC:</b> 2026, TBA, Nihon Shipyard	3 vessels

AFAGC : Ammonia fueled ammonia gas carrier, ABV : Ammonia bunkering vessel

\*1 The number of ships is based of management plans as of 2023

\*2 ex. ENGIE Zeebrugge

# Transformation toward net-zero by 2050



- With a growing consensus forming across all sectors to reach net-zero emissions by 2050, a transformation in business, customer preferences, and society and markets is emerging.

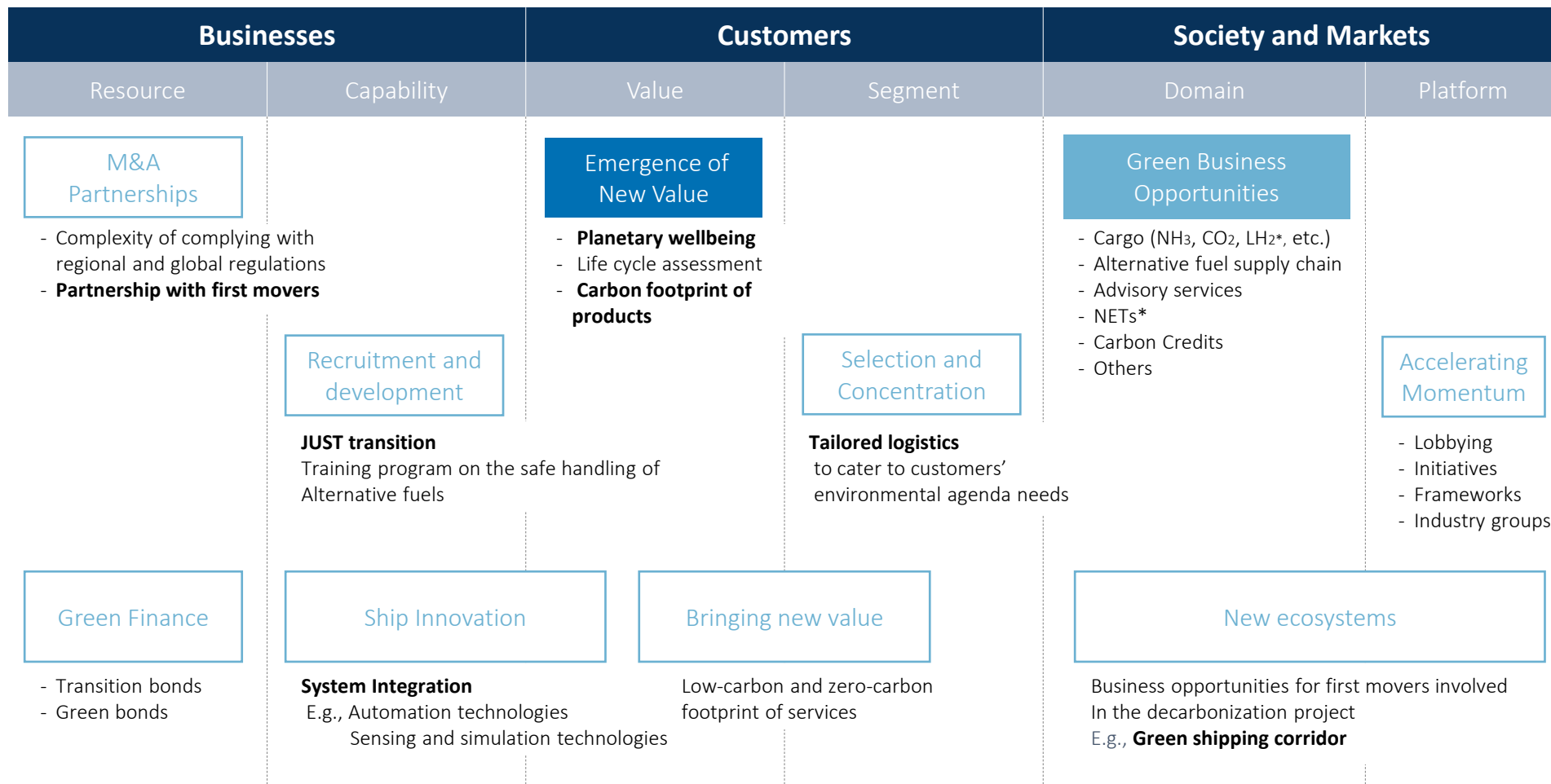

Chapter 02

---

# Decarbonization Strategy



# The Objectives of Our Decarbonization Strategy

Our decarbonization strategy aims to manage increasing **carbon risk** and to realize the **decoupling** of business growth and environmental impact based on the following objectives.

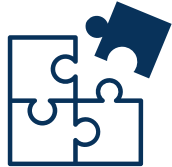

## Fulfilling our responsibilities with respect to climate change

- Complying with relevant regulations and reducing GHG emissions from our business, including supply-chain emissions, to fulfil our social responsibility and meet stakeholder expectations.



## Building a resilient business portfolio

- Building a resilient business portfolio and to remain competitive by managing increasing carbon risk.



## Embracing new business opportunities

- Welcoming new business opportunities in the transition to carbon neutrality.

# Propelling decarbonization strategy forward



- ✔ The decarbonization strategy is being steadily carried out at all stages, from preparation and planning to execution.
- Further, process management based on ISO 14001 (EMS) will be entrenched across.

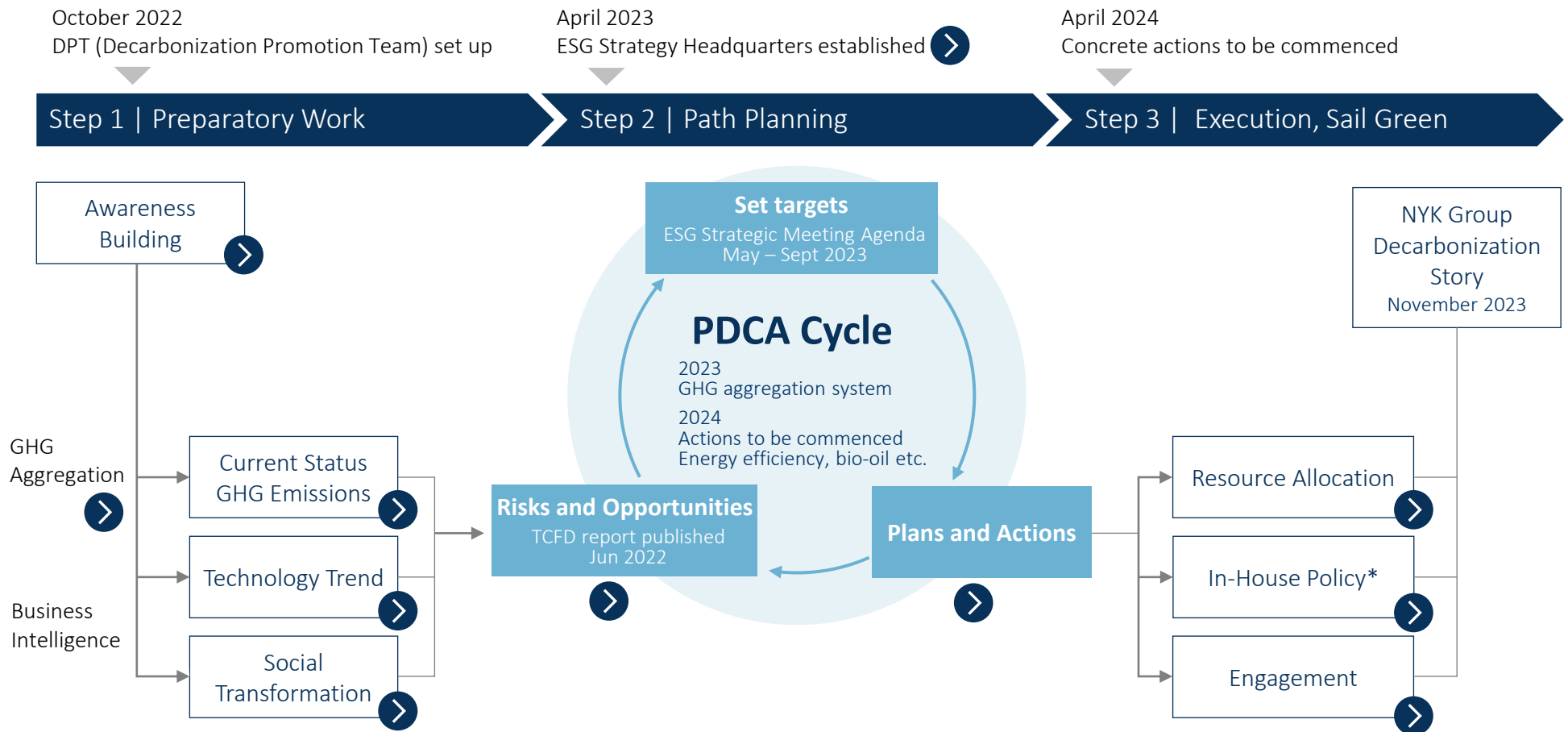

# Path planning – Setting a target: Definition of net zero



- ✔ Our definition of net zero in the 2050 target is clarified to involve carbon removal.

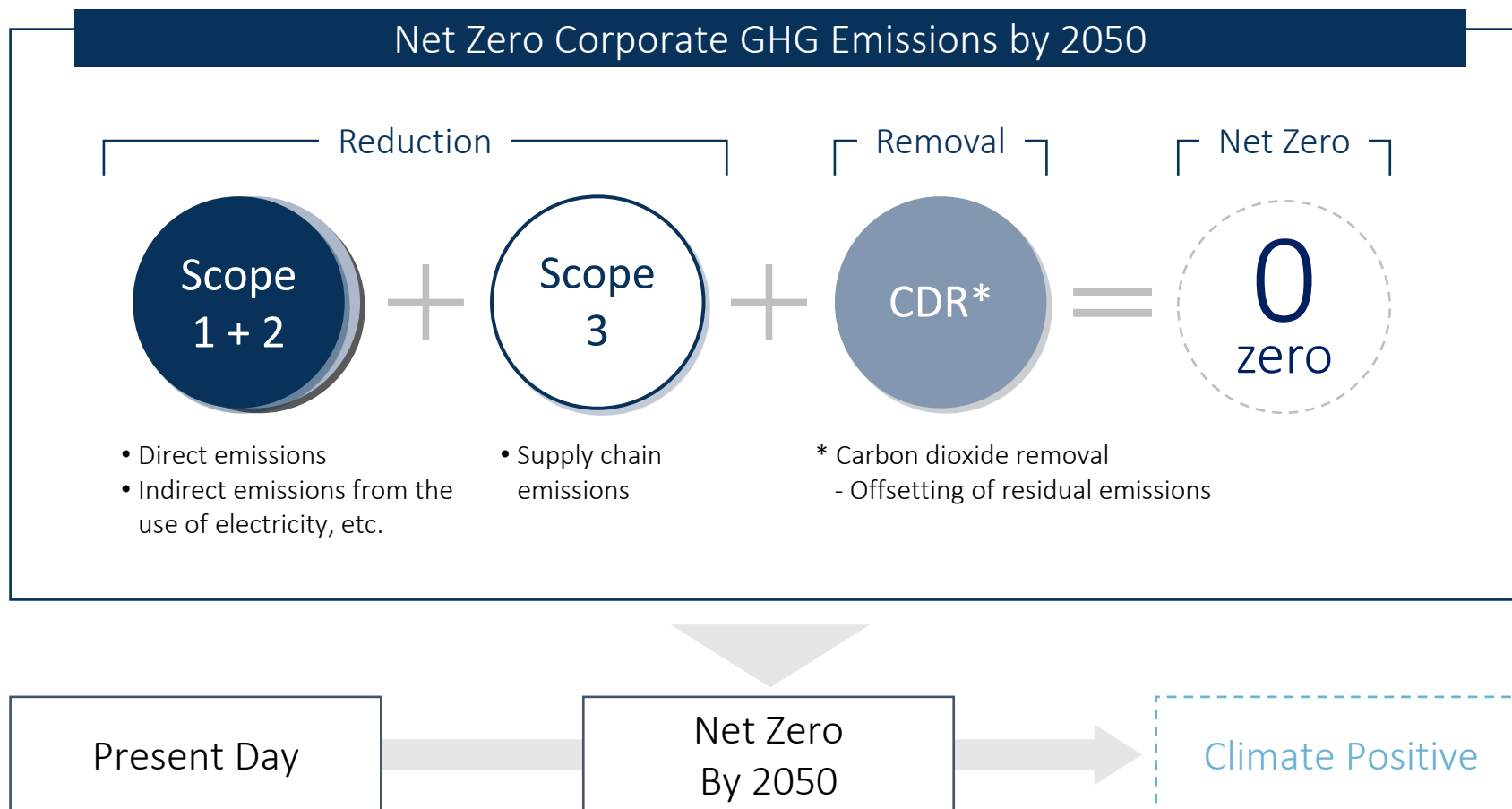

# Ready to set ambitious targets

## **Social transformation responding to the threat of climate change has become a major trend in full swing.**

- The world is accelerating its efforts to balance greenhouse gas emissions and sinks by the second half of this century. We are invited to develop and communicate long-term strategies for a lower and zero-emission society.
- The nature of growth has changed for companies. As uncertainty increases, it is necessary to build a resilient business portfolio and to take the opportunity during the transition to actively communicate the sustainability initiatives of the NYK group to stakeholders.

## **A big gap exists between the backcasting from the decarbonized society we aim for and the forecast from status quo.**

- Will renewable energy and decarbonized fuels become sufficiently produced and available all over the world? Will innovation bridge the gap?
- Gap remains unless we take actions. “Without dreams we have no ideas. Without ideas, we have no plans. No plan, no action, Without action, we can’t succeed at all.” - Shoin Yoshida, Distinguished Intellectual, 1830-1859

## **Abandon the idea of achievable goals and be prepared to set goals that may not be achievable”**

- A carbon budget (\*400-500 Giga ton-CO<sub>2</sub>e) is presented to each of us to curb irreversible climate change around the world.
- In order to become a collaborator for taking climate actions that humanity as a whole desires, it is necessary to show that our efforts and actions are not self-righteous but rather fully aligned with others to achieve collective goals through collaboration with global initiatives.
- Decarbonize logistics, without which the decarbonization of all industries is not possible.
- With long timelines and an uncertain future, strive to spur technical and business innovation rather than rely on current ways of thinking and technology
- “Where there’s a will, there is a way” - Abraham Lincoln, 16th President of United States, 1809-1865



## Path planning – Setting a target (2/2)



- ✔ The NYK Group aims to realize a sustainable society based on a conviction to lead the world toward decarbonization. Accordingly, we will clearly demonstrate our high aspirations and stance of actively promoting decarbonization initiatives both inside and outside of the Group.

### NYK Group Revised GHG Target 2023 aligned with global pathway to 1.5 Deg. C

Medium-Term Target		Long-Term Target	
	Fiscal Year: April to March		
FY 2021	Base Year	( - )	
FY 2030	Target Year	FY 2050	
<b>45%</b> Reduction	Target	<b>Net-Zero</b> Emissions	
<b>Absolute Corporate Emissions</b>	Unit	<b>Absolute Corporate Emissions</b>	
Scope 1 + 2	Scope	Scope 1 + 2 +3	
<ol style="list-style-type: none"> <li>1. Aligned with science-based target</li> <li>2. Indicative Checkpoint 60% by 2035 and 70% by 2040</li> </ol>	Remark	<ol style="list-style-type: none"> <li>1. CDR applied</li> <li>2. Subject to availability of zero-carbon and/or carbon-neutral fuels.</li> </ol>	

Find our history of GHG reduction target



Chapter 02-1

---

# GHG Reduction and Removal Plan



# Way to reduce absolute emissions

- ✔ Aiming to maintain business activity to fulfill responsibility as a part of social infrastructure, our goals are to **maximize energy efficiency** and **minimize carbon intensity**.

## Emissions

[ton-CO<sub>2</sub>e\*]

\*CO<sub>2</sub>e: CO<sub>2</sub> equivalent

## Business Activities

[ton-cargo x mile]



## Efficiency

[ton-fuel / (ton-cargo x mile)]



## Intensity

[ton-CO<sub>2</sub>e/ton-fuel]

### Technical Assessment

- GHG Reduction Measures

### Economical Assessment

- GHG Abatement Cost

### Accelerators

- Public Policy: (Int'l Shipping) IMO EEDI/XI/CII, Market-Based Measures, GFS etc. (Other Sector) Carbon Tax, Emission Trading Scheme etc.
- Private Sector: Corporate Internal Carbon Pricing, Reduction Targets etc.

\*EEDI: Energy efficiency design index for newbuilding, EEXI: EEDI for existing vessel, CII: Carbon Intensity Indicator, GFS: GHG fuel standard,

See the Appendix for information on the current situation of world shipping activity and energy efficiency.



# Identified shipping reduction measures



- ✔ All hands on deck with every possible measure to reduce GHG emission.  
We do expect other innovative options to be a part of this important role together.

## GHG reduction measures (maritime)

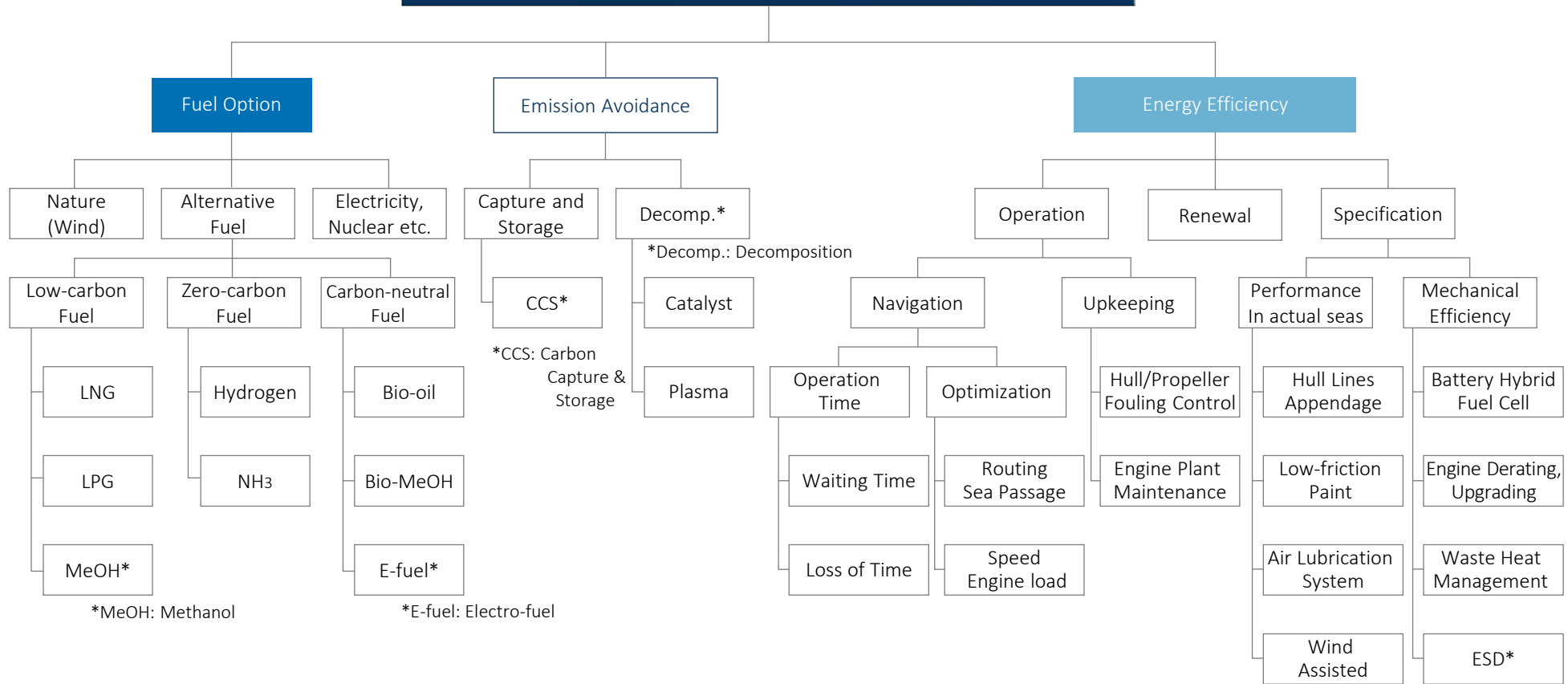

\*MeOH: Methanol

\*E-fuel: Electro-fuel

\*ESD: Energy Saving Device

# GHG abatement cost and Internal Carbon Price (ICP)

- Abatement costs have emerged as a key tool to drive the decarbonization of economies, reduce decarbonization cost and assess the efficiency of a technology.

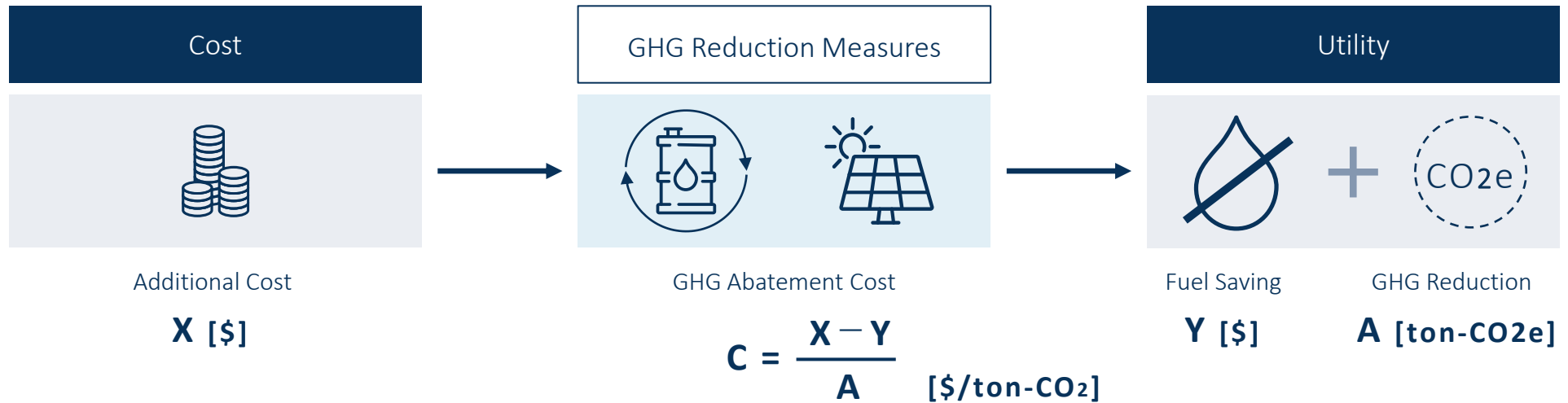

- ICP is a mechanism to price carbon within a company to use it as an incentive to promote decarbonization, to identify the risks and opportunities, or to guide investment decisions.

- It is also possible to control the emissions of an entire company depending on the scope of application of the ICP and the setting of prices. NYK started using ICP in 2021 as an impact visualizer and is now moving on to the second stage to extend its utilization to the investments and the evaluation of businesses performance.
- Our ICPs set in 2023 are \$120 from 2023 to 2026, \$200 from 2027 to 2030, and \$250 after 2030.**

# GHG reduction technologies - Reduction potential and its abatement cost

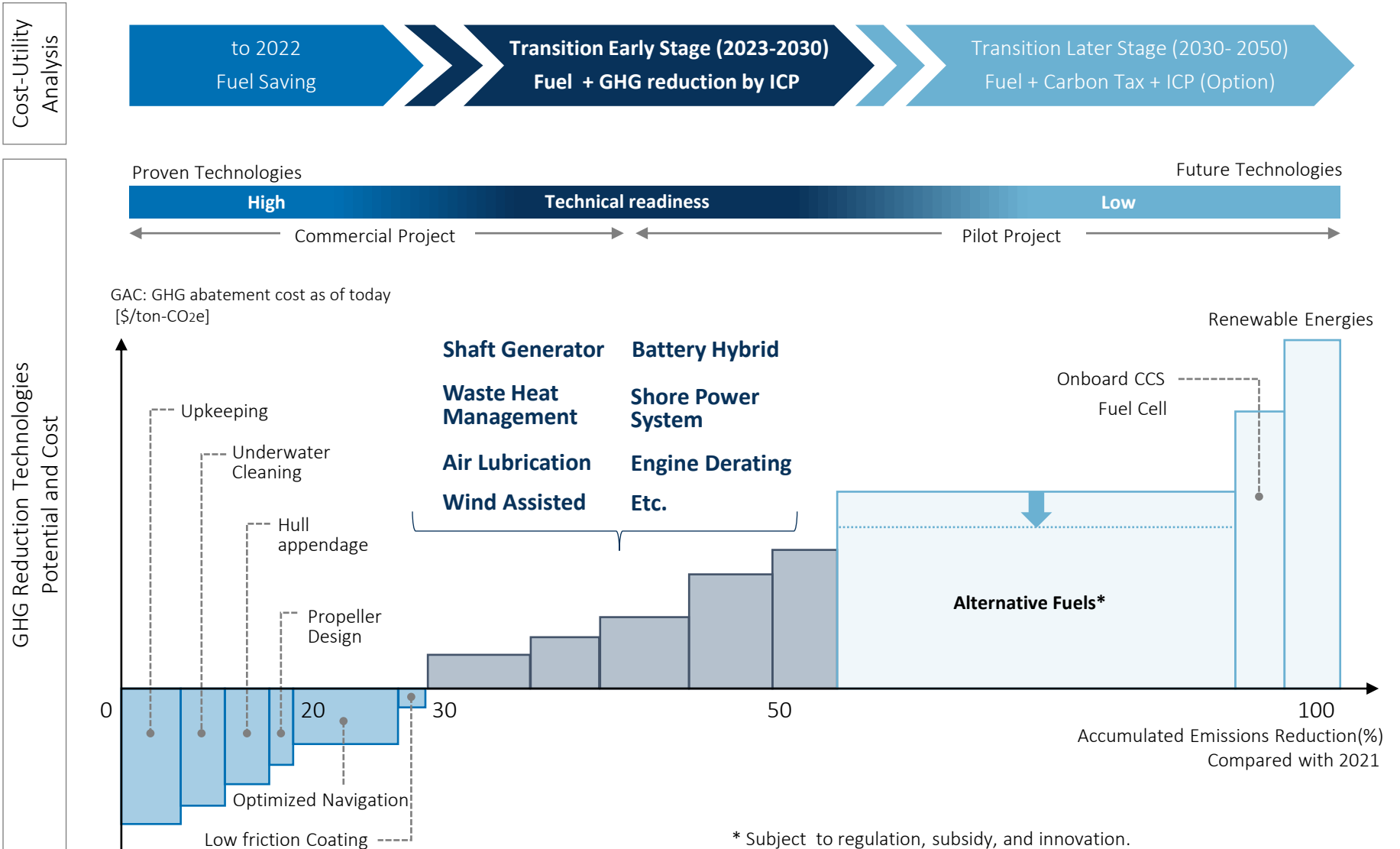

Figure: Abatement Cost Evaluation for GHG mitigation measures (Illustration only)

\* Subject to regulation, subsidy, and innovation. Especially GAC will be reduced by carbon tax such as EU-ETS (2024 onward), FuelEU Maritime (2025 onward) or IMO's medium-term measures (2027 onward).

# GHG trajectory and its economic impact assessment

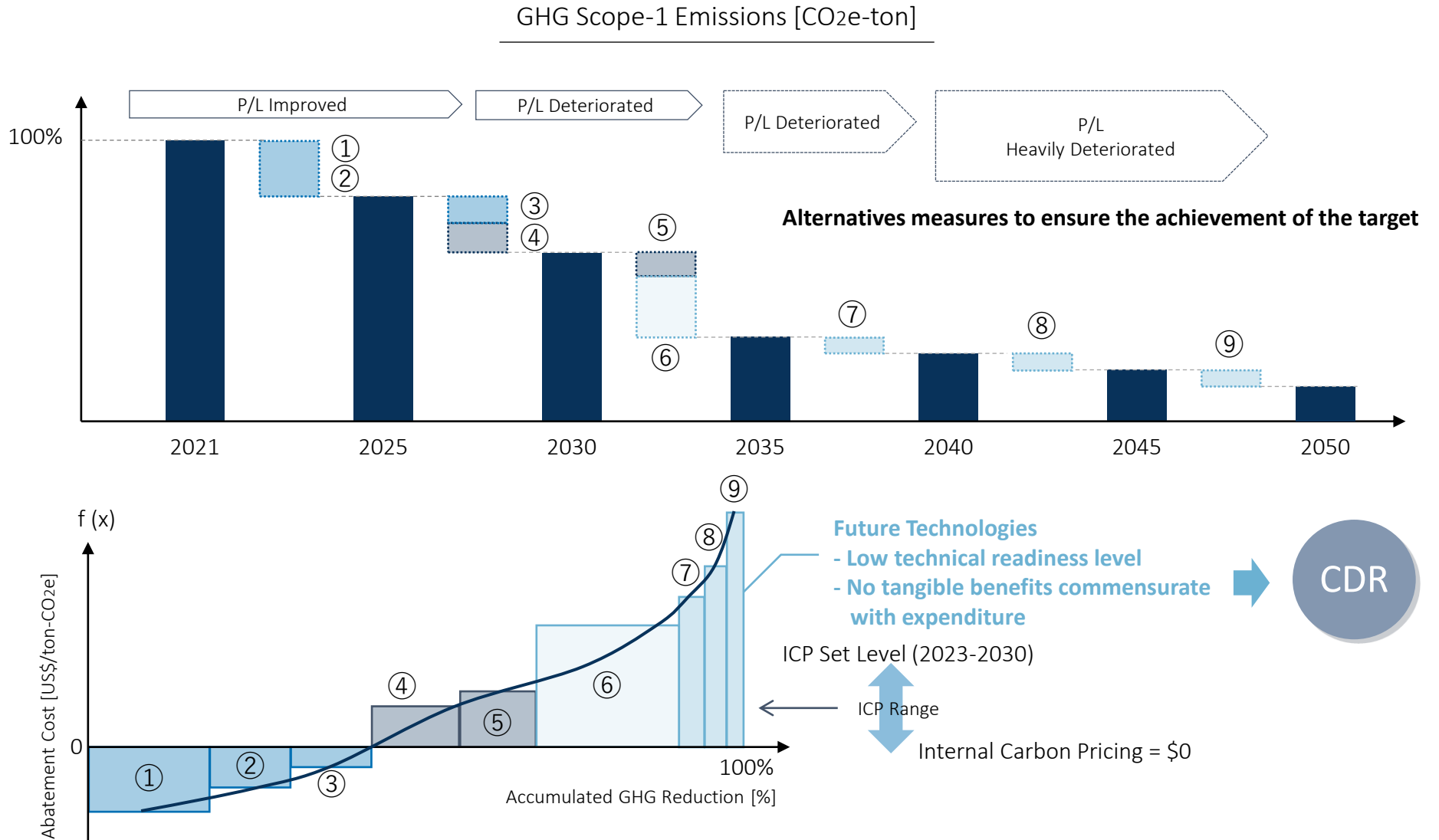
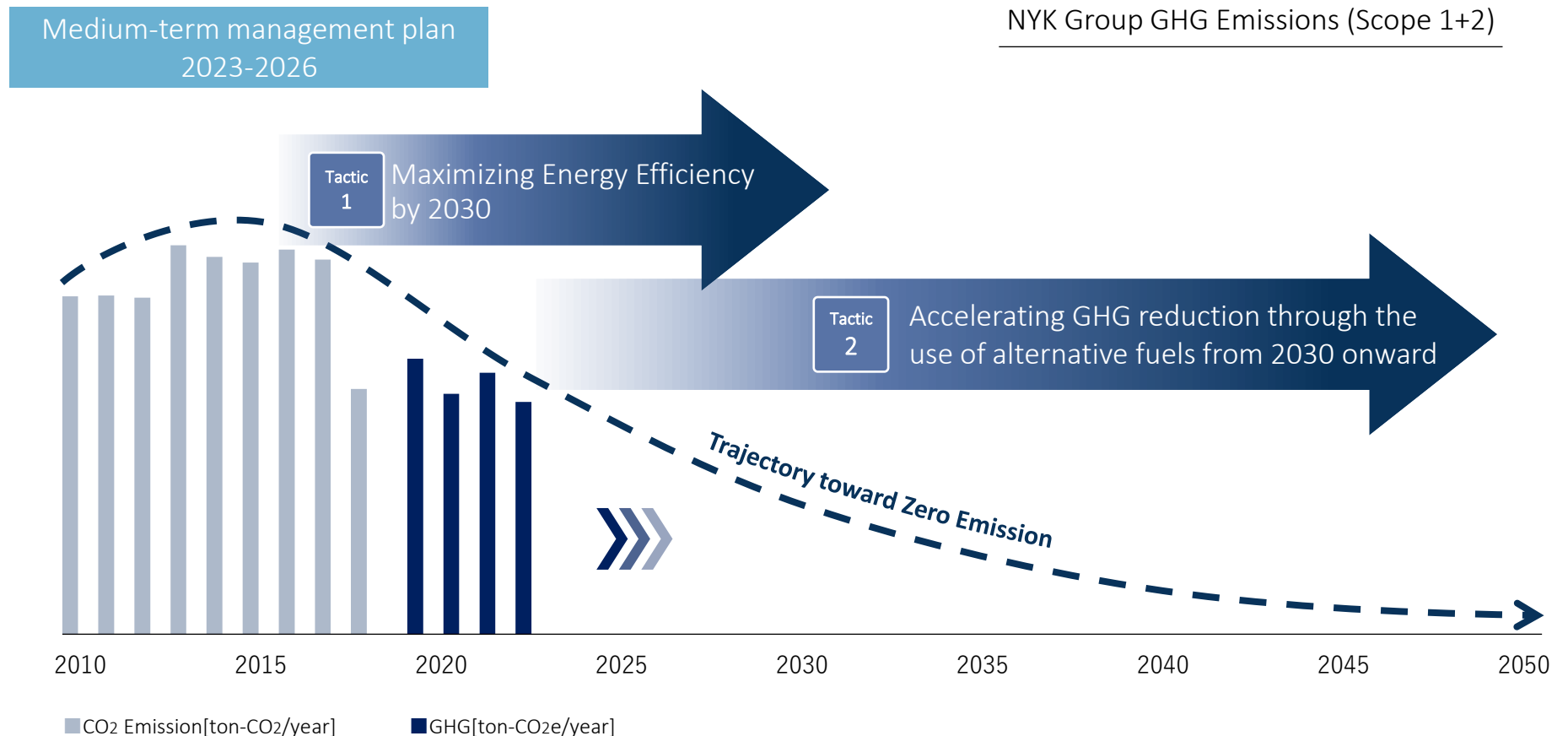

Figure: Abatement cost evaluation for GHG mitigation measures (Illustration only)

# Prioritizing the reduction of GHG scope 1 + 2 emissions



- ✔ **The trajectory toward zero emissions** shows how NYK Group plans to reduce its GHG emissions with tactics of energy efficiency and alternative fuels.





# Tactic 1: Maximize energy efficiency by 2030



Due to the limited access to zero-carbon and carbon-neutral fuels before 2030, it is prudent to maximize the energy efficiency of the existing fleet through various options.

- Keywords: Operational optimization (Passage planning, Navigating speed, hull conditions, Arrival time etc.)  
Fouling control, Performance improvement in actual seas, Engine optimization and partnerships

## Energy Efficiency

### Operational Improvements

Sharing the best management practices  
Within an organization adapting to digital transformation

	Name of Framework
Officers	ESG Strategy Committee *
Management	GHG Reduction Task Force Best Management Practice Sharing (2-4 times /year)
Vessel Operator	IBIS* Challenge Workshop specialized for improvements in vessel operations (4 times /year)
All Employees	IBIS Frontier Study session on decarbonization and ESG as a whole 300-400 Participants (4 times in FY2022)

\* IBIS: Innovative Bunker and Idle-time Saving

### Enhancement of Technical Capabilities

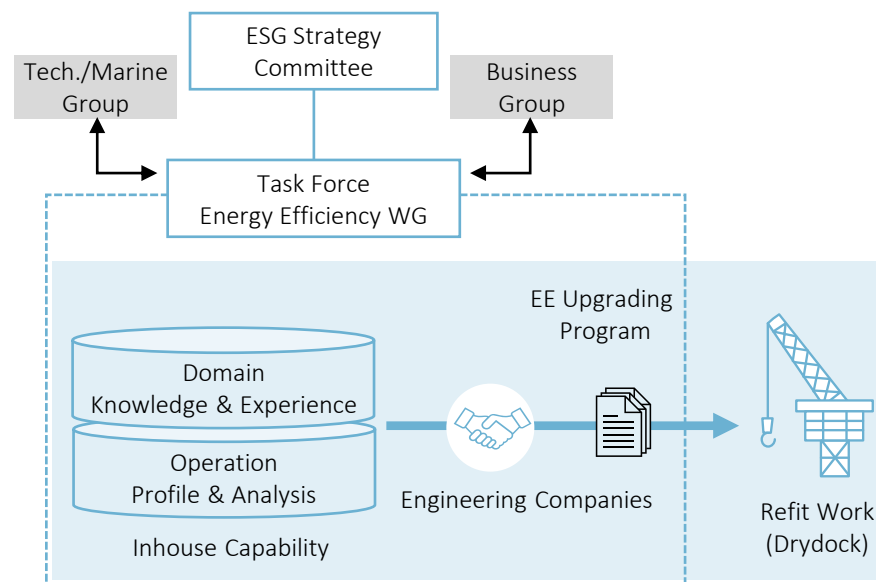

Phase 1: 2024-2026 (3 Years) Target 10% improvement  
Phase 2: 2028-2030 (3 Years) (TBA)

\* ESG Strategy Committee : See Appendix “Decarbonization governing structure”



# Tactic 2: Acceleration of GHG reduction through the use of alternative fuels



- ✔ We will build a resilient fleet** through immediate reductions that include considerations for other environmental impacts (such as oil spill risk, SOx, NOx, and black carbon) in the transition.
  - Onboard CCS may play an important role in the transition subject to the maturity of the CO2 supply chain.

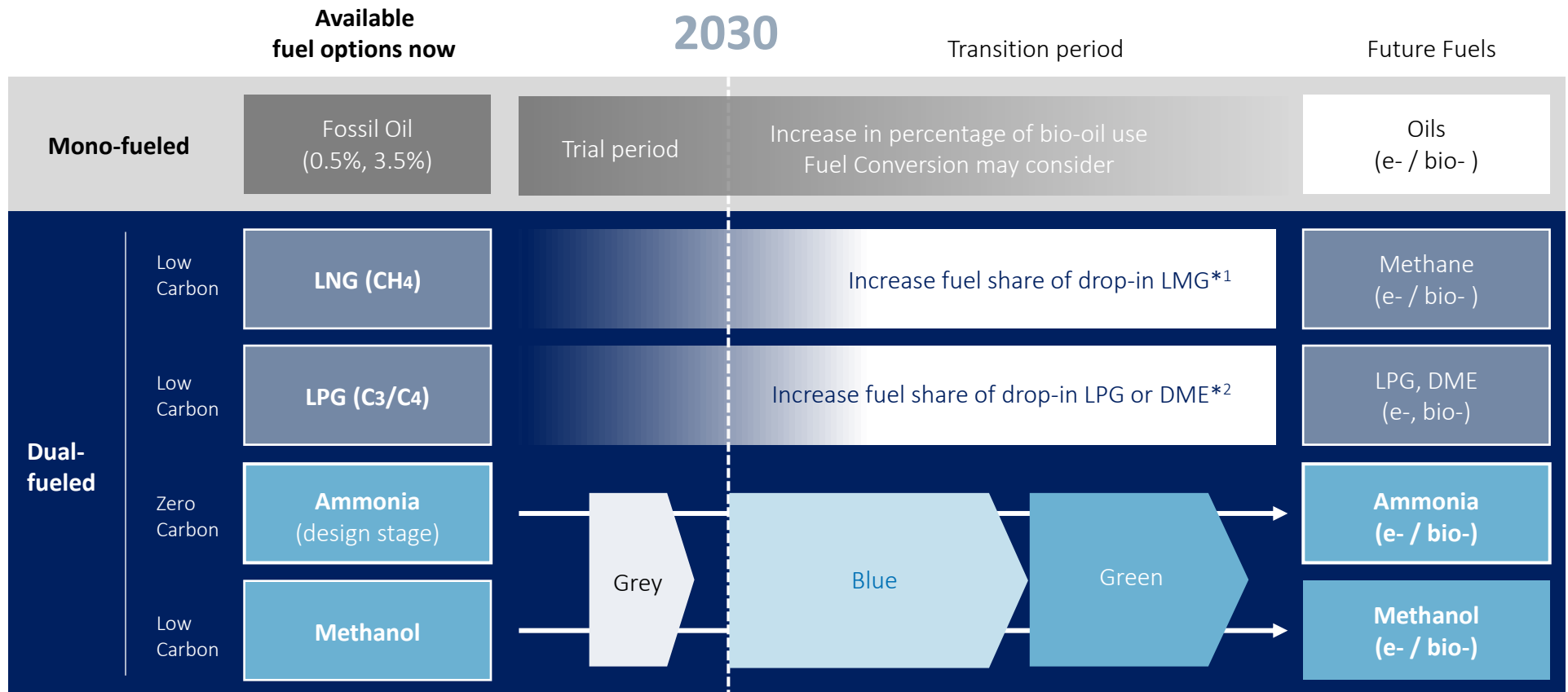

For simplicity, the secondary fuel like MDO/MGO is omitted.

\*1 LMG: Liquefied renewable Methane Gas

\*2 DME: Dimethyl ether

# Ammonia energy carrier for maritime decarbonization (1/2)

✔ Industry is showing clear signals in moving clean ammonia technologies forward.

## New technologies to drive energy transition

- 01 **Quantitatively significant impact** on energy transformation (EX)
- 02 **Technical readiness level (TRL)** sufficient to implement within 10 to 20 years
- 03 **Cost Level** that society can bear
- 04 **Supply Chain Decarbonization**



## Ammonia as an energy carrier

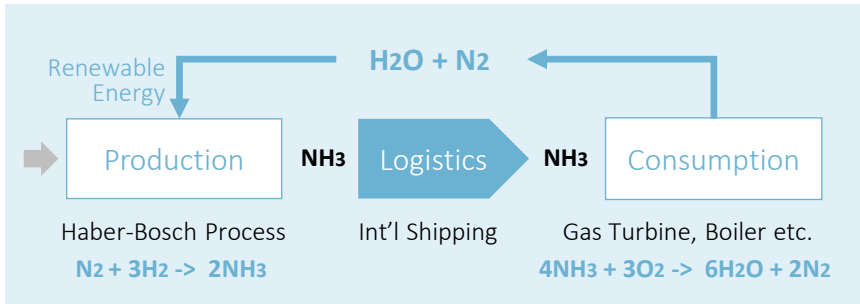

Reference: Cross-ministerial Strategic Innovation Promotion Program in Japan

## Expected ammonia demand (1.5 C Scenario)

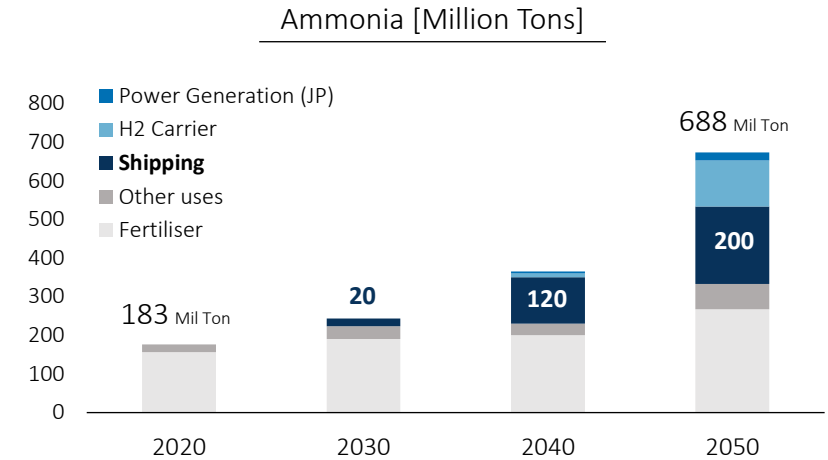

## Existing Global Supply Chain

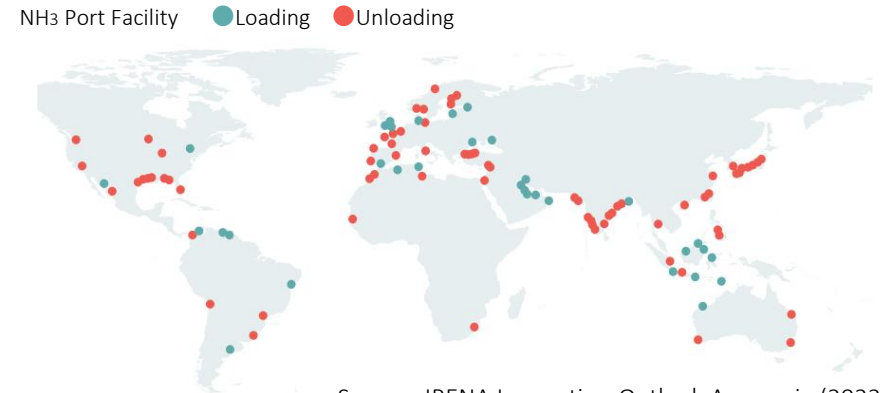

Source: IRENA Innovation Outlook Ammonia (2022)

# Ammonia energy carrier for maritime decarbonization (2/2)

- ✔ Use of gas as ship's fuel requires specific measures to ensure safe operation.
  - The challenge remains how to control the risk of toxicity when gas is leaked or accidentally released into the atmosphere. Lowering said risk to an acceptable level through technical solutions and further risk reductions via our operational excellence in gas carriers could help.

## Toxic Properties of Ammonia

### General Design and Human Factor Approach

### Project Specific Approach

Risk Mitigation Area	Solutions (Specific to NH <sub>3</sub> in bold)
Ship Design and Arrangement	Tank, Compartment, Cofferdam Arrangement
Fuel Containment System	Proven Design (IMO Type-A/B/C)
Material and Pipe Design	Double-Wall Piping System Double Block and Breed System
Bunkering	Quick Coupler, Emergency Release System
Ventilation	Redundancy and <b>Enhanced Capacity</b>
Fuel Supply to Gas Consumers	Emergency Shut-Down System
Fire Safety and Explosion Protection	Gas Detection System Water Spray System
Control, Monitoring, and Safety Systems	Emergency Shut Down System Automation System ( <b>Advanced</b> ) <b>Ammonia Detox System</b>
Drill, Training, Certificate	In-House Training Facilities and Programs Experience building in owned DF vessel

Project-Based Risk Assessment		
<u>HAZID</u> Hazard Identification	<u>QRA</u> Quantitative Risk Assessment	<u>HAZOP</u> Hazard and Operability Study

### Operational Concepts and Insights

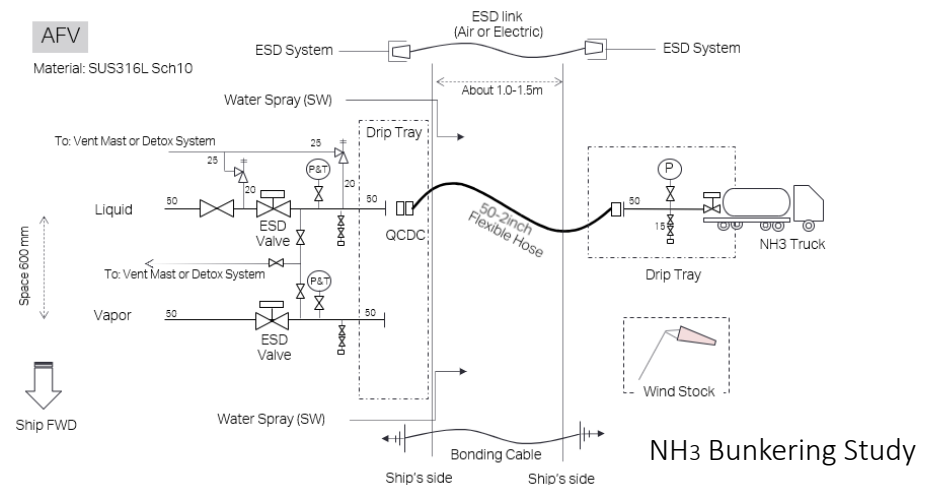

## Tactic 2: Use of bio-oils

- Increasing the use of bio-oils as drop-in fuels would have an intermediate effect and be a long-term solution based on a stepwise approach to keep vessels-in-operation safe.

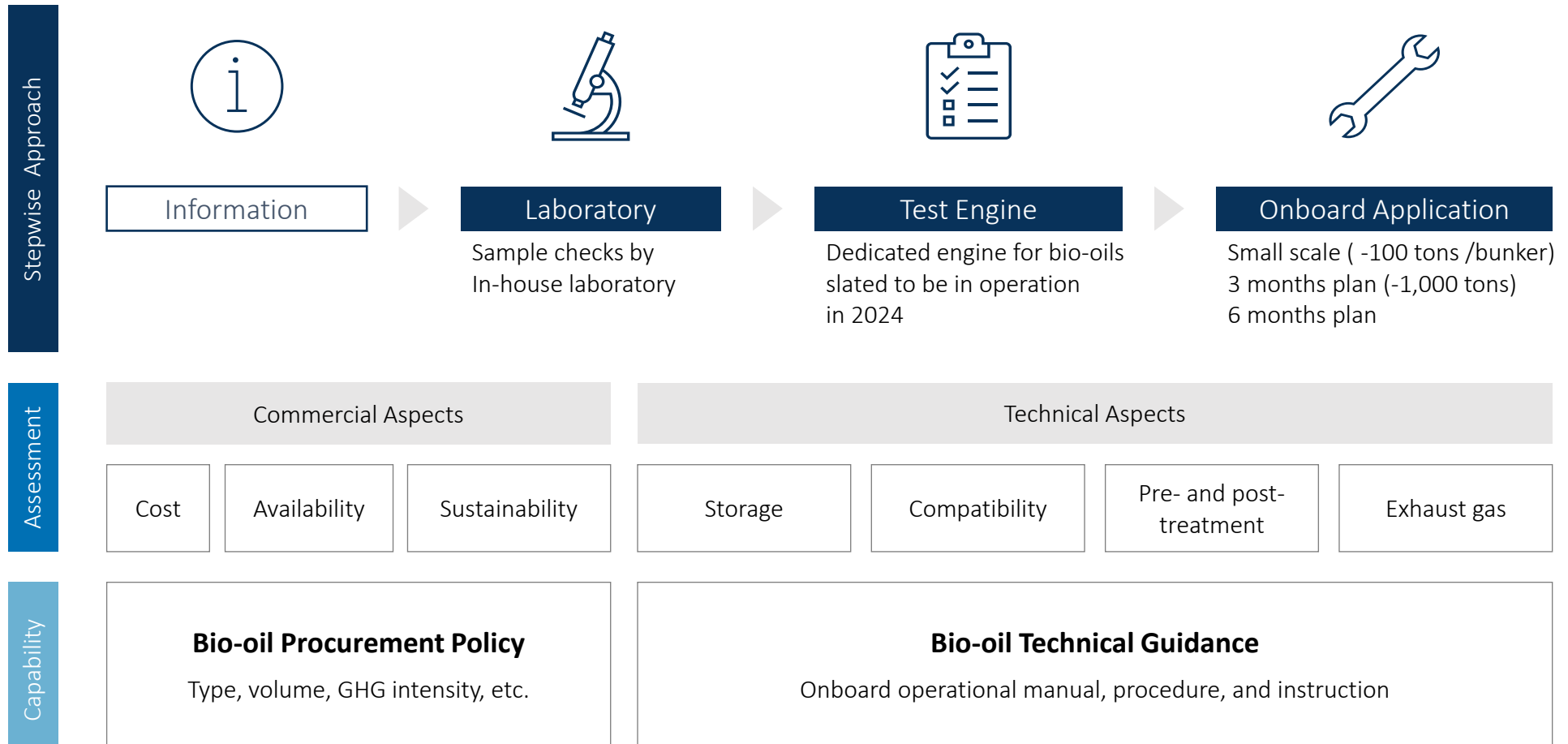

# Balancing residual GHG emissions – Role of CDR

## ✔ 1.5 deg. C aligned climate scenarios project **the need of CDR to achieve net zero.**

- In global shipping, which is a hard-to-abate sector, a GHG emissions reduction close to 100% is expected be challenging to achieve from both technical readiness and maturity and economic standpoints
- Carbon dioxide removal (CDR) is a necessary element to achieve net-zero CO<sub>2</sub> and GHG emissions both globally and nationally, counterbalancing residual emissions from hard-to-transition sectors. Reference: IPCC WG3 Chapter 12

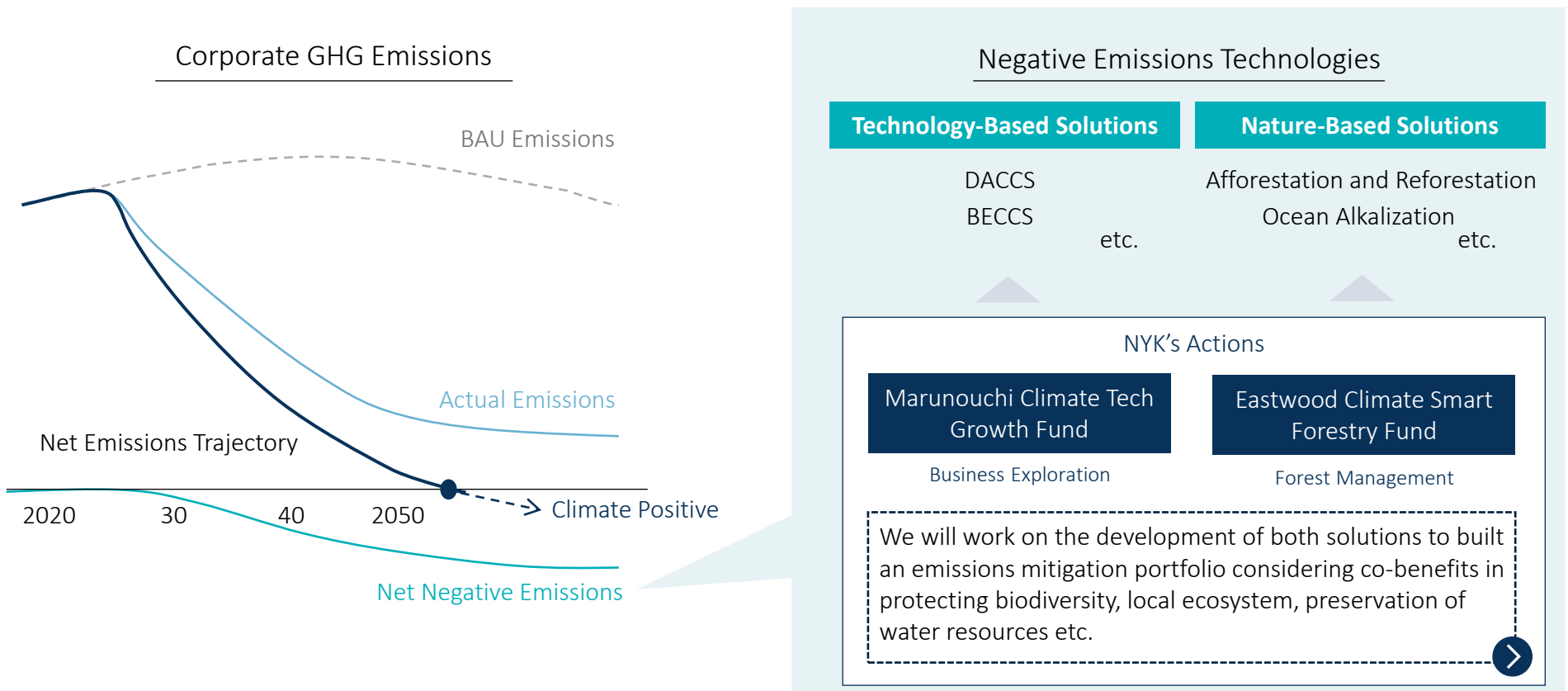

# GHG Scope-3 emissions reduction



✔ **Stakeholder engagement** is vital to success in reducing GHG scope 3 emissions.

- It is best to engage with like-minded suppliers and customers who have ambitious targets for realizing a low-carbon society and reducing their carbon footprint of product.

## GHG Scope-3: Way forward to reduction

01

**Awareness building**  
workshop on Scope 3

02

**Set system boundary and structure**  
appropriate metric, boundary, etc.

03

**Data aggregation and validation**  
to confirm data creditability

04

**Policy and disclosure**  
with concrete reduction plan

05

**Stakeholder engagement**



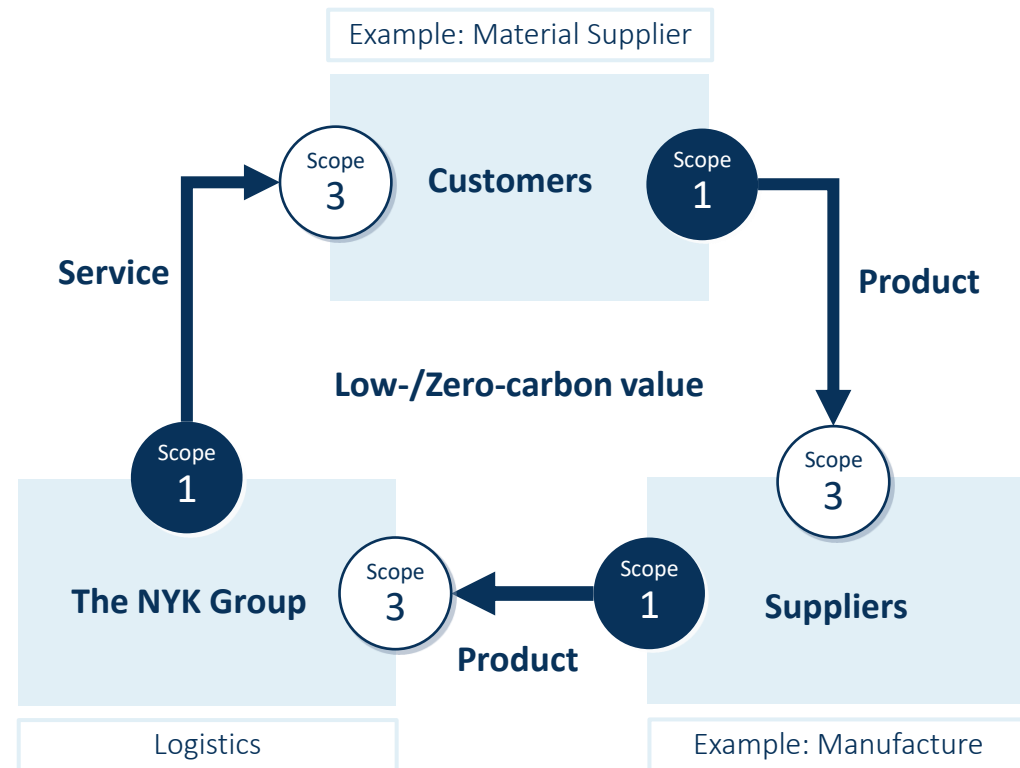

## Sharing the value of low-/zero-carbon in supply chain



## Engagement – World-leading initiatives, in which NYK actively participates



- NYK is determined to join efforts and make contributions to initiatives facilitating and accelerating the **decarbonization of the global maritime industry by building a neutral and open platform for cross-disciplinary collaboration**, thereby becoming a global, visible driving force in decarbonizing the entire maritime industry.

Initiative	 <b>Mærsk Mc-Kinney Møller Center</b> for Zero Carbon Shipping	
NYK Joined	In 2020 as Founding Partner	In 2023 as Strategic Partner
Location	Copenhagen, Denmark	Singapore
Founding Partners	7 ABS, A.P. Moller-Maersk, Cargill, MAN-ES, MHI, NYK Line, Siemens	7 BHP, BW, DNV, MPA, ONE, Eastern Pacific Shipping, Seatrrium
Strategic Partners	24 Incl. FP	3 Hapag-Lloyd, BP, NYK LINE
Projects involved	NH3-Fueled Vessel / Bunkering Concept, Quantitative Risk Assessment, Green Shipping Corridor etc.	Drop-in Bio-oils Etc.

See other partnerships <https://www.nyk.com/esg/technology/green/> 



# The NYK Group GHG emission trajectory toward 2050



## ✔ Efforts toward net-zero emissions by 2050

- Four milestones are set along the reduction pathway.

■ Scope-1+2 □ Scope-3 ■ Removal

(million tons)

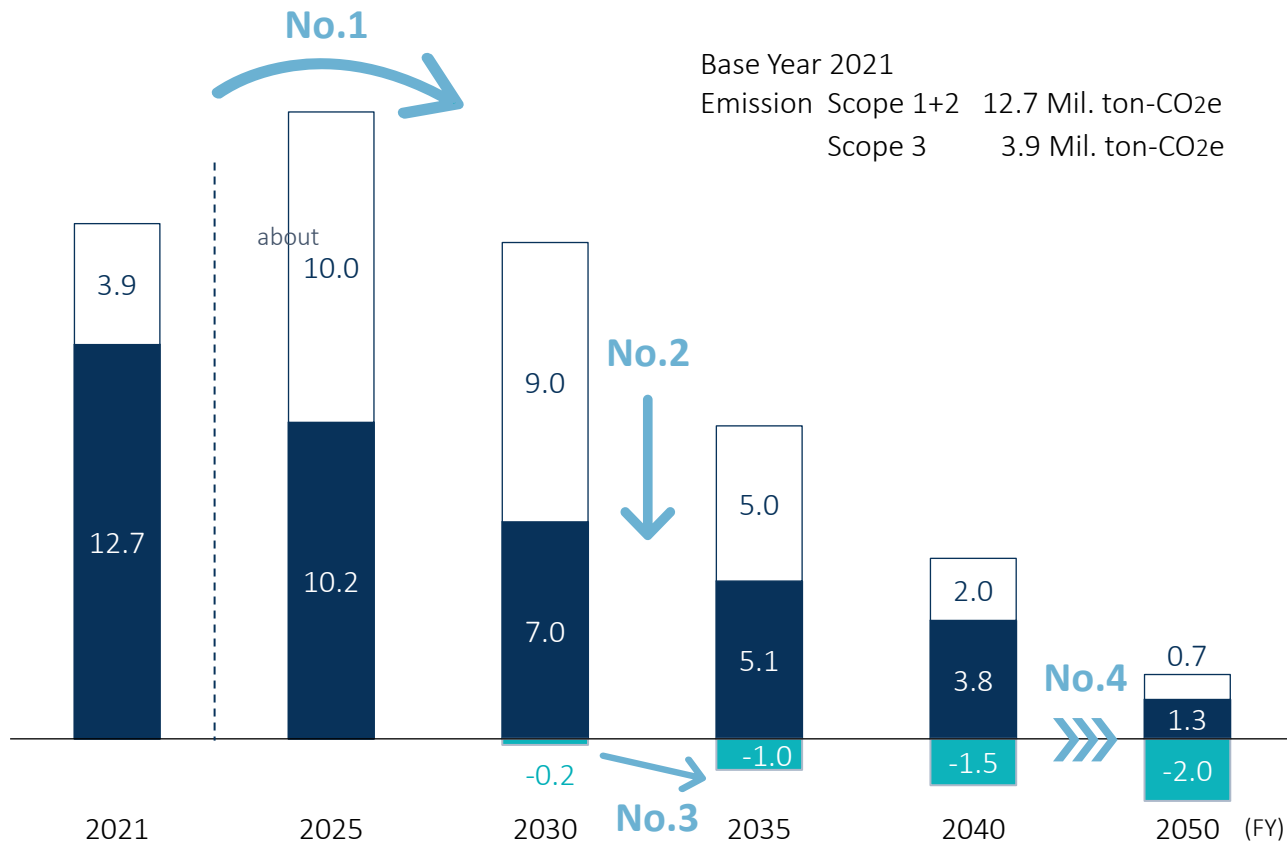

### No.1: GHG emissions peak

By 2025

Total GHG emissions include Scope 3 emissions regarding to peak out

### No.2: Achievement of Medium-term target (Scope 1+2)

45% reduction by 2030

< Indicative Checkpoints >

- 60% reduction by 2035

- 70% reduction by 2040

### No.3: Removal

Neutralization of residual emission through use of negative emission technologies to be started around 2030

### No.4: Net Zero

Across all scopes and businesses

# Roadmap of GHG reduction plan

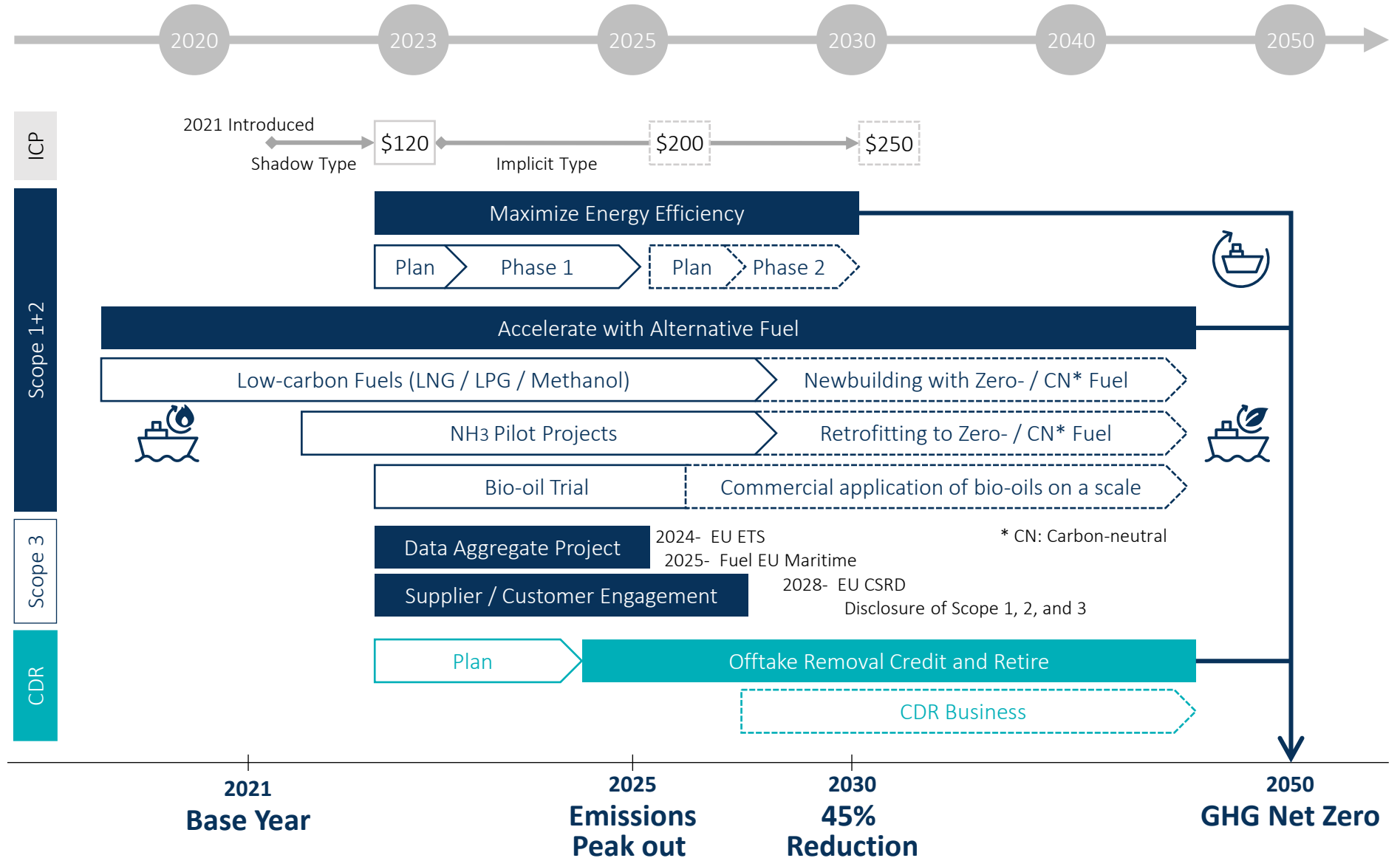

Chapter 02-2

---

# Concept for Sustainable Growth



# Sustainable growth



- ✔ Through decarbonization, the NYK Group is to achieve sustainable growth while reducing its group GHG emissions including scope 1+2+3.
  - Historically, there has been a close correlation between economic growth and environmental degradation.
  - In the transition to a sustainable society, the value of logistics may change in the eyes of the customers.

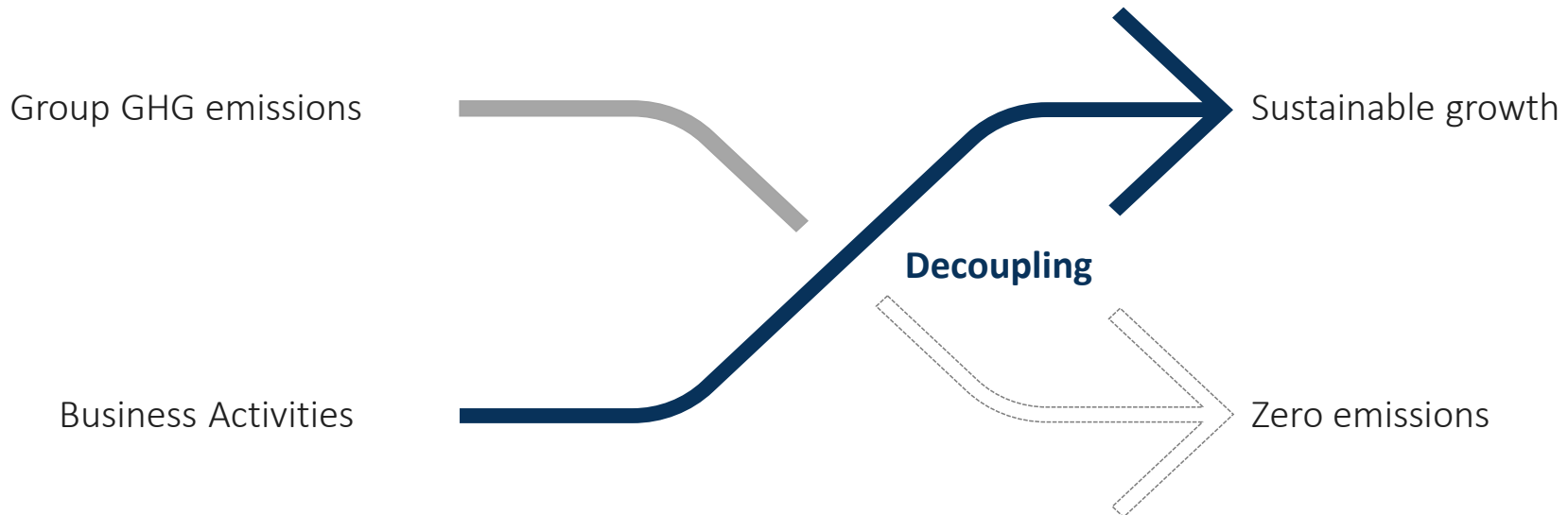

# Our actions toward sustainable growth



Transformation to a sustainable society

Our actions to drive transformation



## Emerging New Value

Climate-Friendly, Environmental Footprint



## Carbon Footprint of Product

Performance Indicator, Supply Chain



## Regulatory Boundaries

Tank to Wake, Well to Wake, LCA

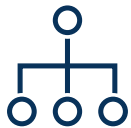

## Data Free Flow with Trust\*

Carbon Accounting, Data Creditability



## Green Shipping Corridor

Cross-Sectors, First Movers, Demonstrations



## Carbon Footprint of Service

Baseline, Creditability, Mass-Balance, B&C\*



## Emissions Data QC and QA

Standardization, Validation, and Verification

\* Open exchange of data based on trust relationships

\* B&C: Book and Claim

# Hypothesizing a customer's willingness to pay (WTP)

✔ **Planetary Wellbeing** can be the value that the customer is willing to pay.

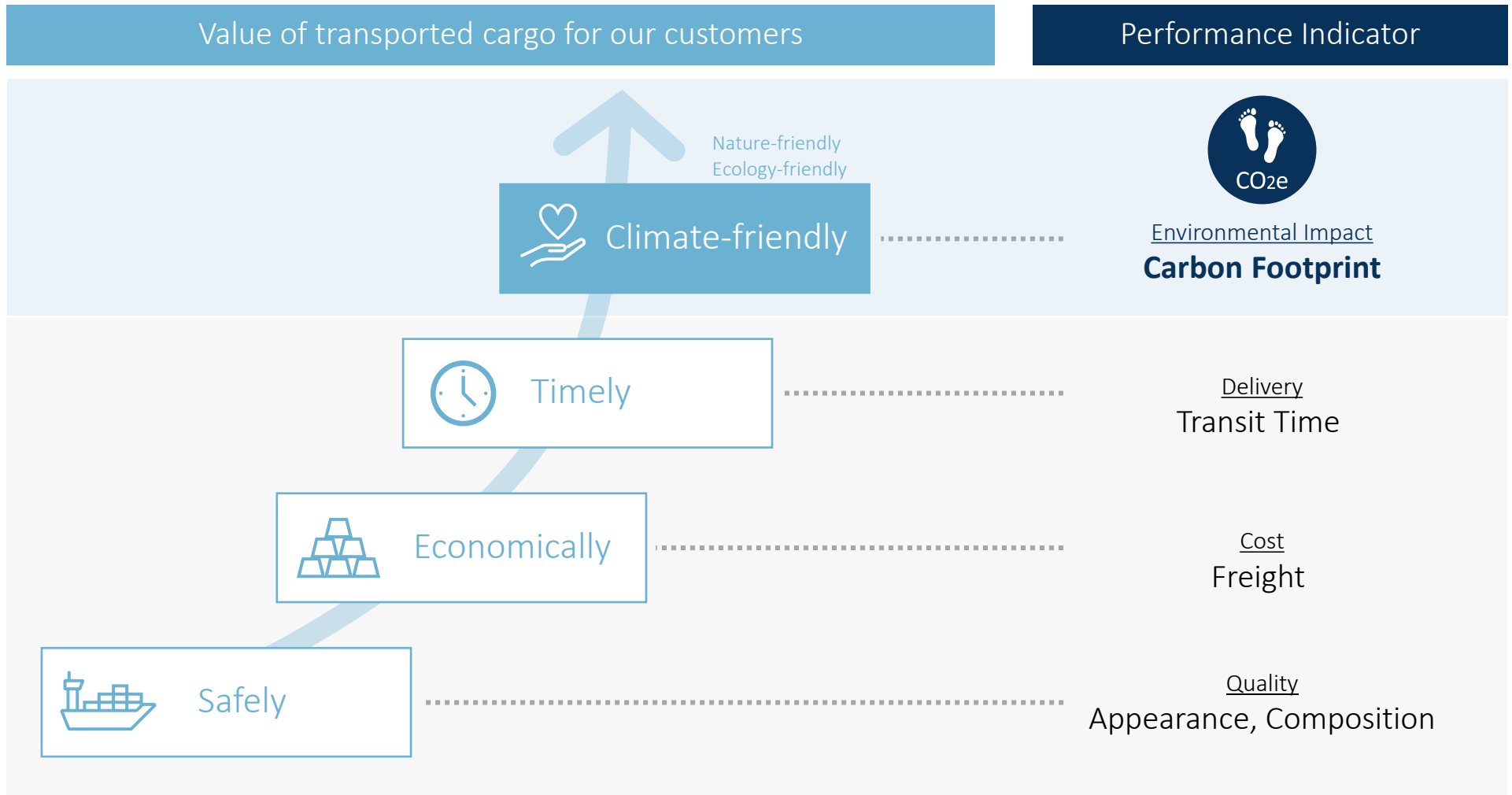

# Expanding regulatory boundaries

- With the advent of electric vehicles, the scope of the GHG regulations have expanded throughout the lifetime of a product, which will affect the logistics sector.

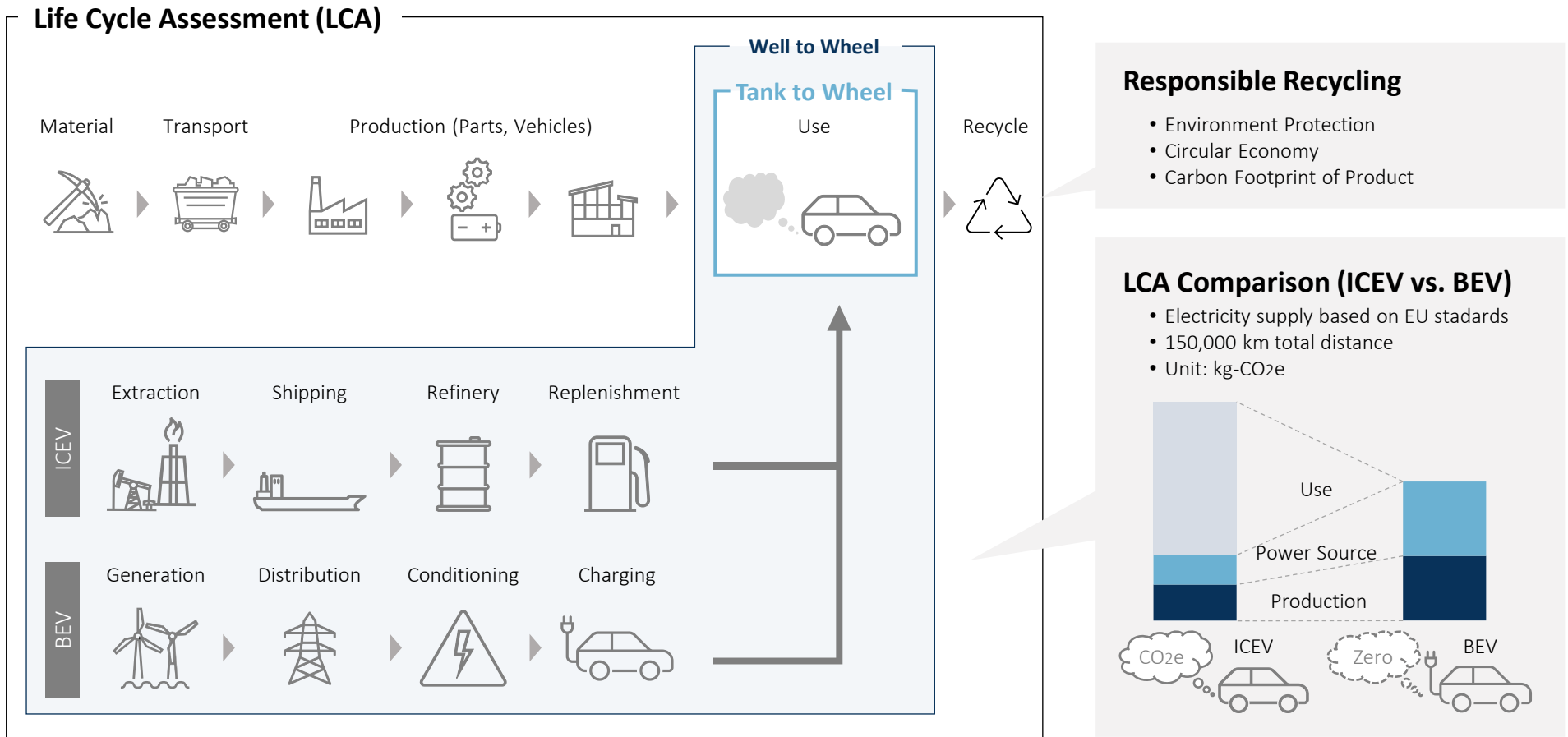

Reference: Life cycle assessment in the automotive sector (2018, Francesco Del Pero etc.)

ICEV: Internal combustion engine vehicle, BEV: Battery electric vehicle

# CFP (Carbon Footprint of Product) gaining momentum



## ✔ Social need for GHG reduction on a product-by-product basis

- Attention is growing with regard to addressing GHG emissions over a product's lifetime = **Carbon Footprint of Product.**
- To reduce the CFP, all players (or participants) in the supply chain have an important role and responsibility.
- Carbon accounting now becomes key to data integration.

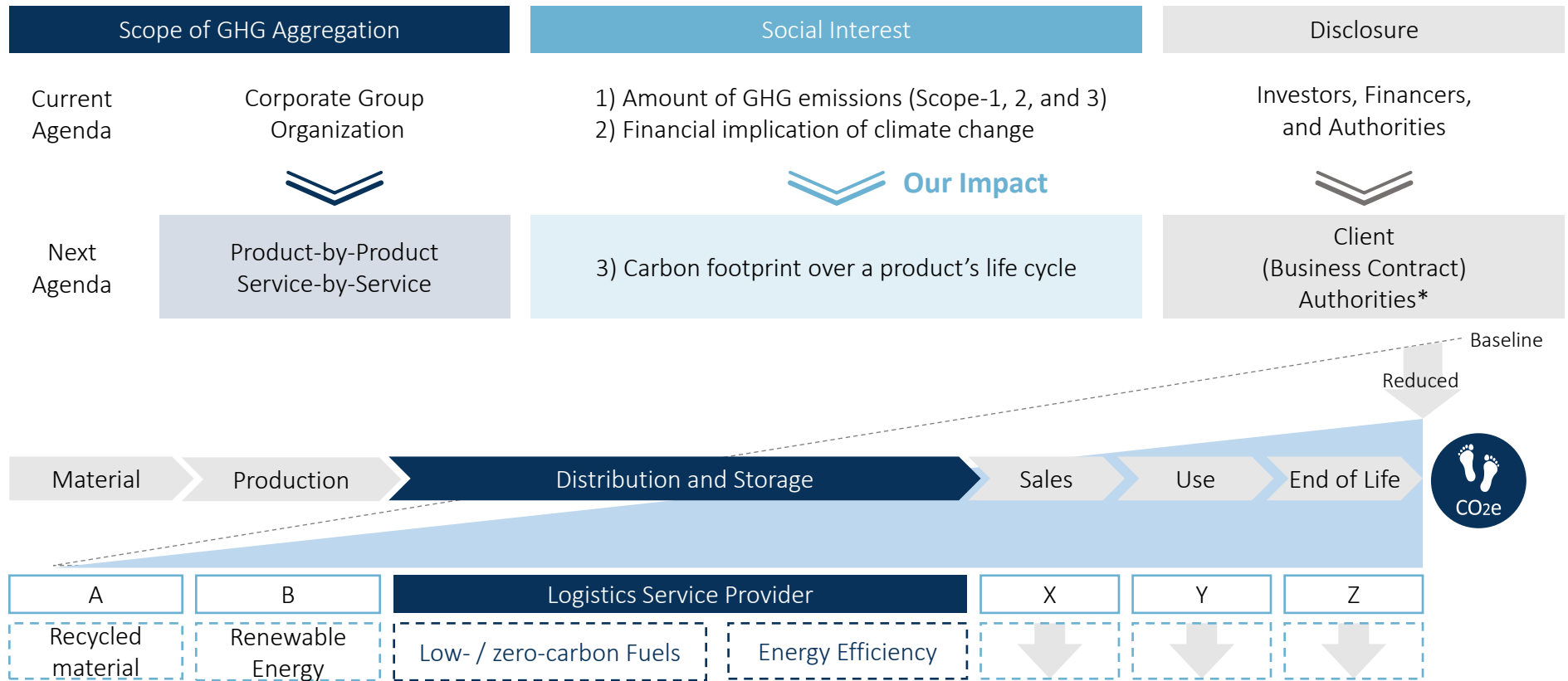

\* EU: Battery Regulation, Carbon Boarder Adjustment Mechanism etc.



# Data Free Flow with Trust (DFFT) enables the delivery of SDGs



- ✔ The concept of **Data Free Flow with Trust (DFFT)** aims to promote the free flow of data while ensuring trust in privacy, security, and intellectual property rights.
  - Free data flows can help address pollution, climate change, and other sustainability objectives by minimizing waste and increasing traceability across sustainable supply chains.
  - Reducing the carbon footprint : End-to-end supply chain transparency and sharing of actual and verified emission data, not estimates or averages, down to the individual product and supplier level is needed. \*1

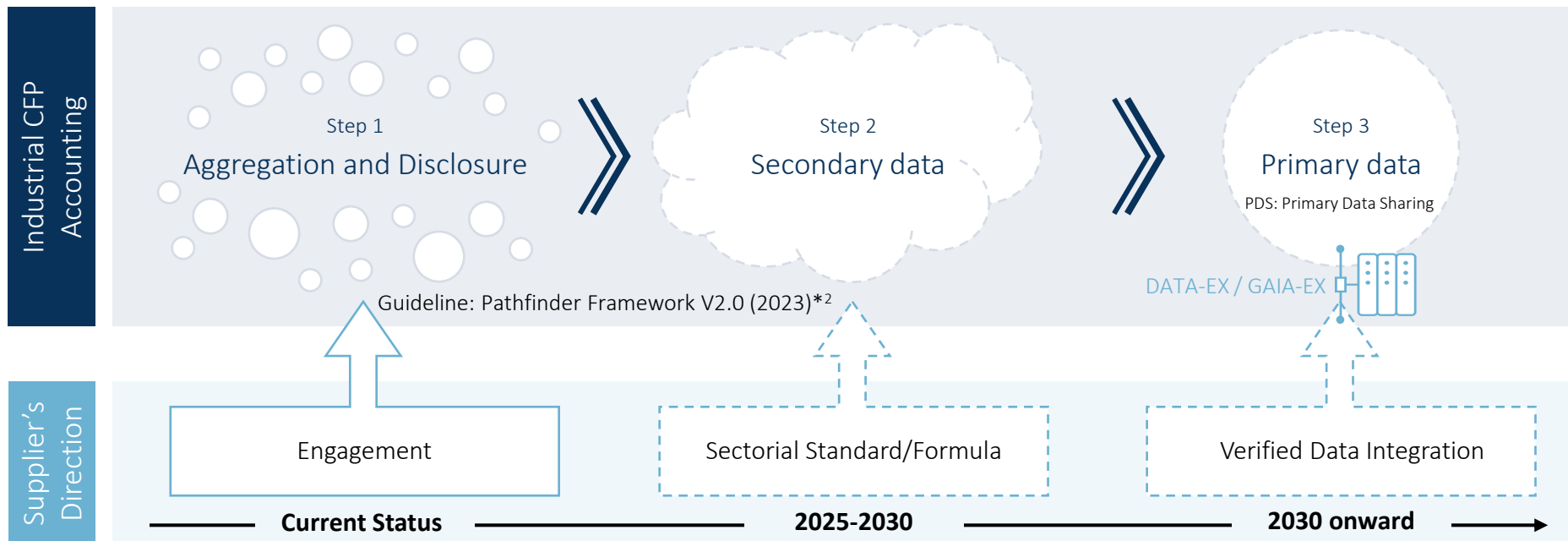

\*1: Source: <https://www.digital.go.jp/en/dfft-en> 

\*2: WBCSD Pathfinder Framework <https://www.wbcsd.org/Programs/Climate-and-Energy/Climate/SOS-1.5/Resources/Pathfinder-Framework-Version-2.0> 

# Valuating carbon footprint of service (CFS)

- ✔ The nature of carbon footprints is invisible. The **credibility** of emission data to prove the footprint becomes important as a performance indicator for the customer and service provider.
  - Credibility = Data Transparency + Traceability + Accountability
- ✔ **Low CFS** is to value the GHG reductions from the agreed baseline.

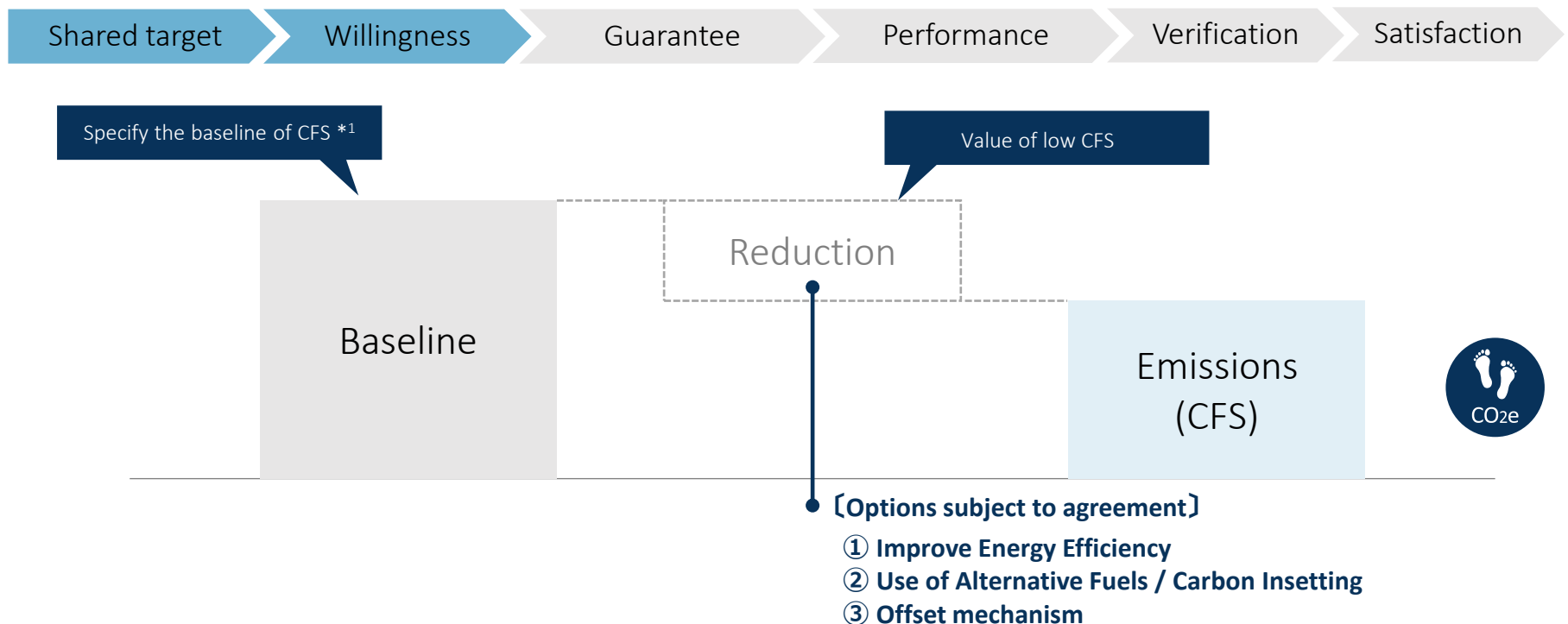

\*1: It may refer to Industrial Standard or it can be set as project specific baseline subject to mutual agreement.

# GHG emission data quality control and assurance (GEQC/QA)

- ✔ The demand for emission data assurance may grow to ensure that actual GHG missions are consistent with the self-declared amounts.

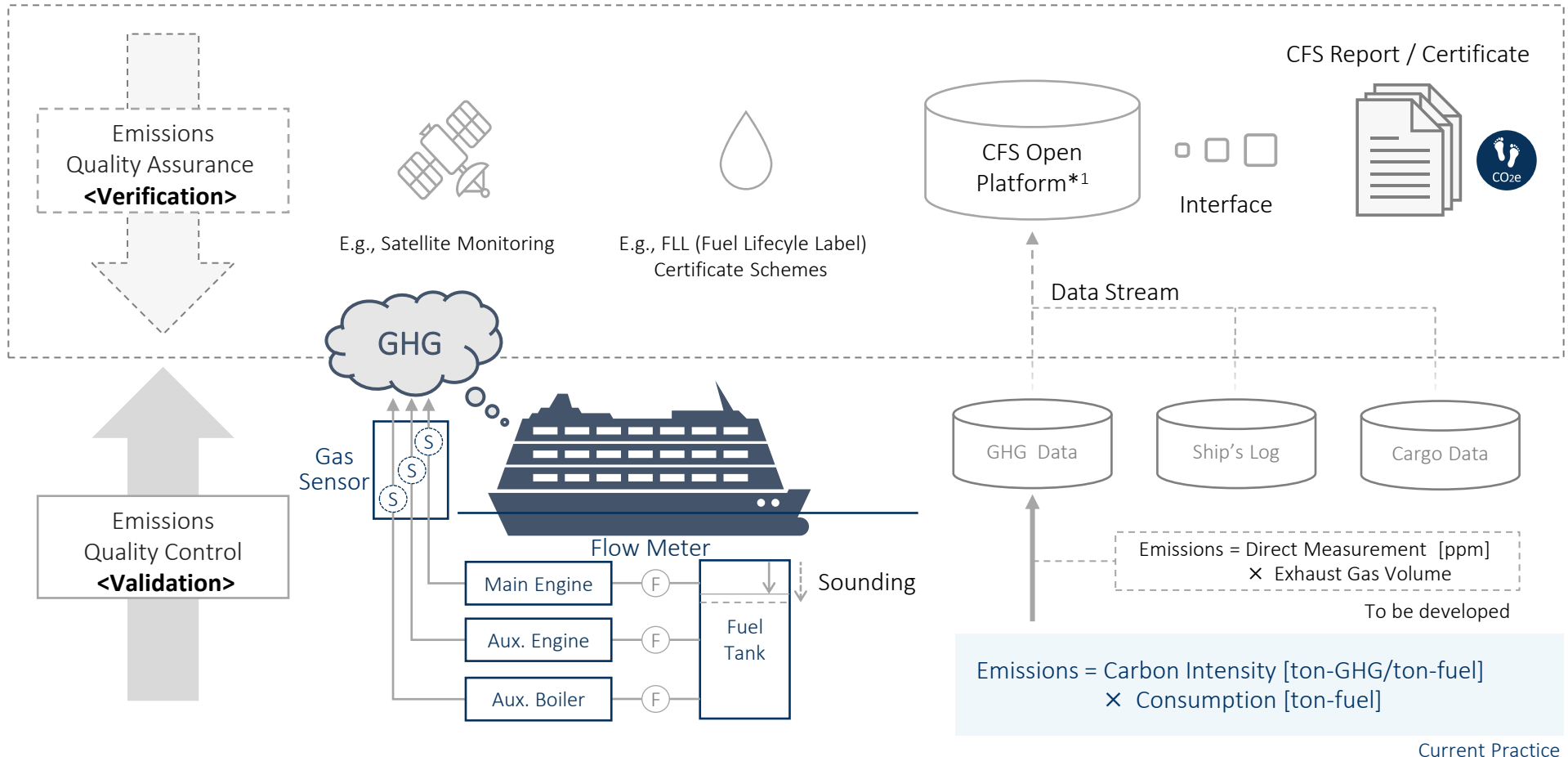

Carbon Intensity: Default value or figure in BDN: Bunker delivery note

\*1 Example: IoS-OP (Internet of Ships Open Platform)

Current Practice

# Commercial barriers in the transition to a decarbonized society

- ✔ We need to find a solution to unlock the potential of our decarbonization actions.
  - Industries are fragmented and stakeholders have different interests and mindsets.
  - A level playing field in the IMO (regulatory framework) is expected from 2025 onwards at the earliest.
  - Frequent rule changes could inhibit investments due to the lack of predictability.
  - The lifetime of an oceangoing vessel is about 15 to 25 years. Supply chain of alternative fuels needs to cover most of the ports in the world. So, the transition to a decarbonized society in maritime is likely to take time.
  - How can we accelerate the transition with a limited number of vessels sailing with blue/green fuels?

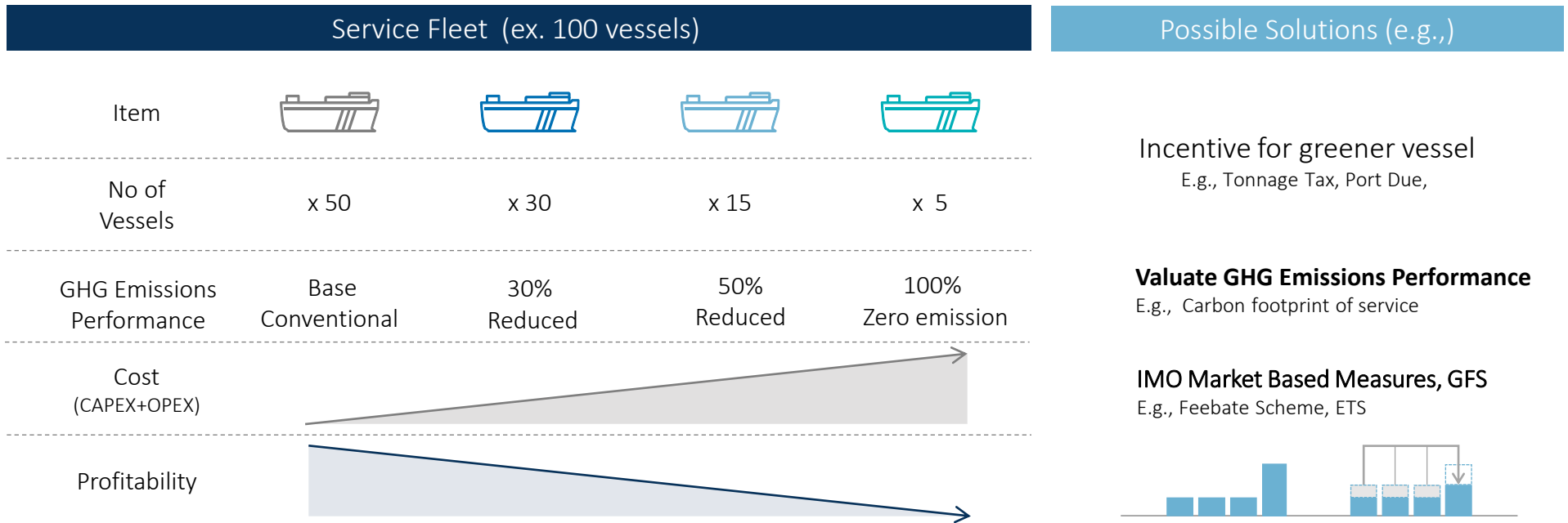

Owner/Operator's willingness to reinvestment to greener fleet will not be promoted.

# Corporate brand ready for use



- ✔ Sail GREEN is a brand that emphasizes NYK's efforts to reduce GHG emissions through the transport of goods and contribute to the eco-friendly supply chains of customers, regardless of the mode of transport (e.g., by sea or land, through terminals, etc.).



## Mass Balance Concept

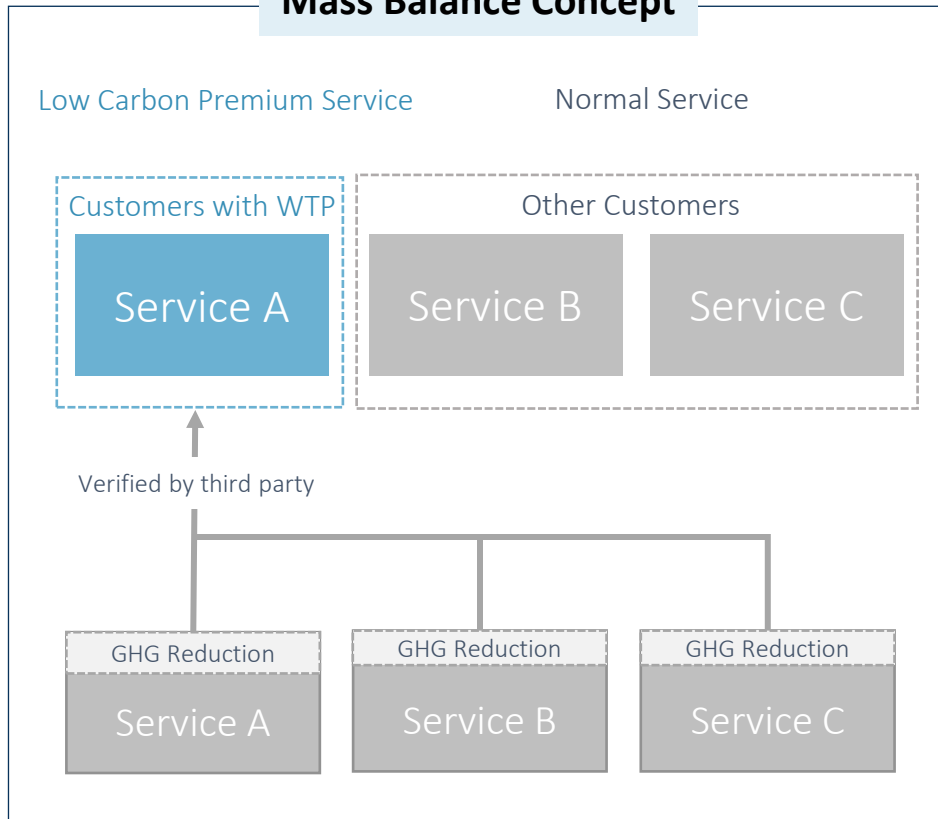

## Identity Preserved Concept

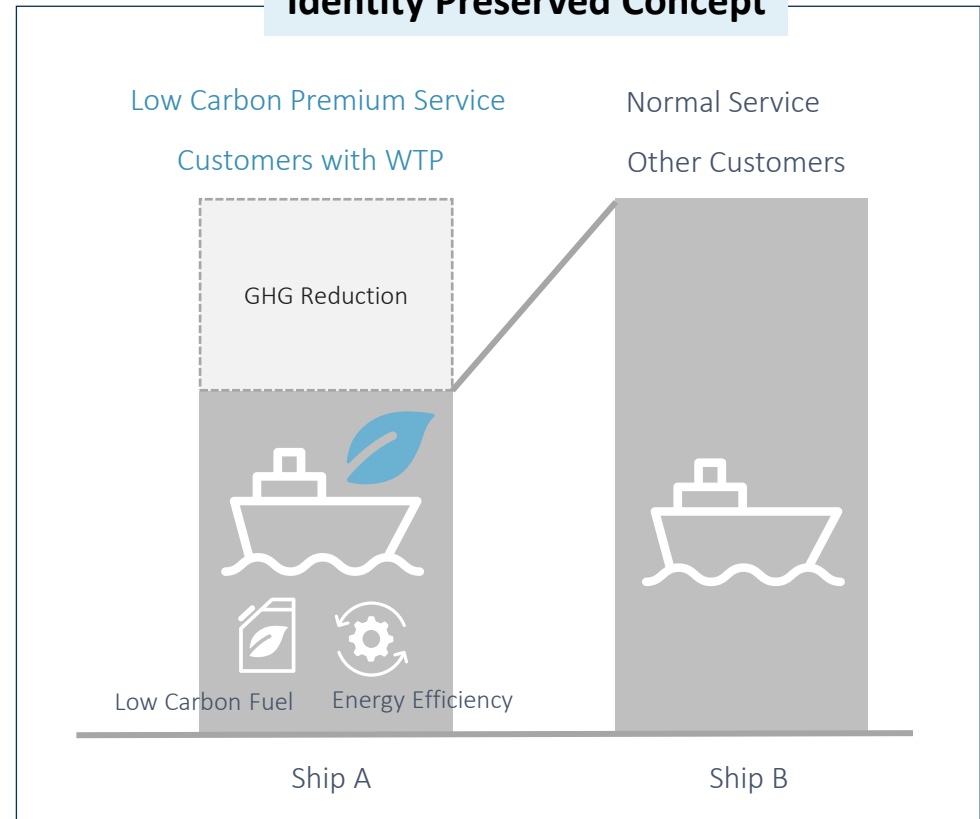

# Showcase of zero carbon shipping to accelerate decarbonization

## ✔ Green Shipping Corridor Projects

- Green shipping corridors are expected to act as a catalyst for the global energy transition by providing frameworks for regional and international stakeholders to collaborate on maritime decarbonization goals while aligning with broader regional, national, and international decarbonization initiatives. (reference: ABS – Green Shipping Corridors )

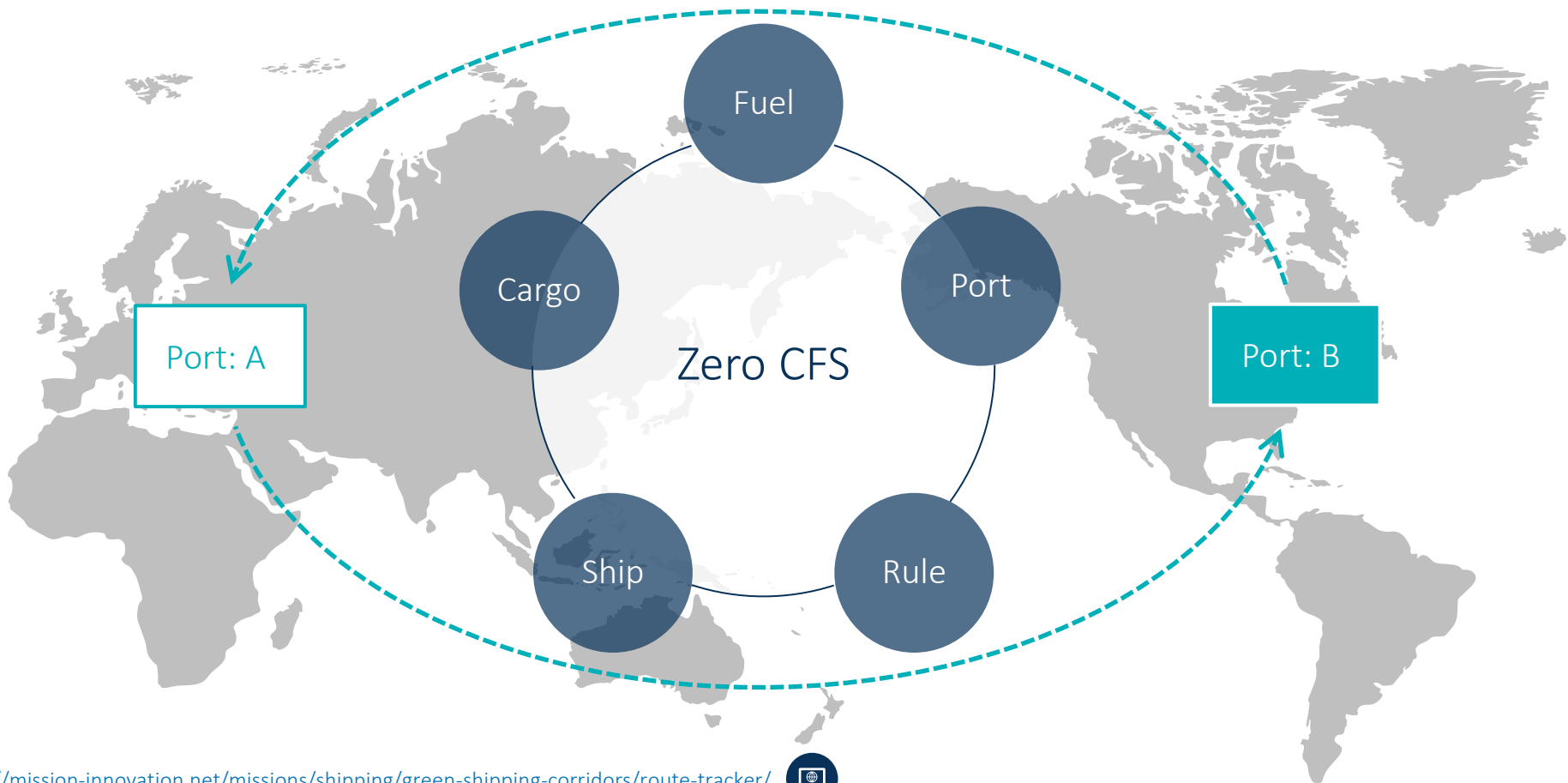

# Business growth through the transition to net zero



- ✔ **The trajectory toward net-zero emissions** shows how NYK will sustainably generate profits through the transition to decarbonization.

Profitability vs. levels of GHG emissions

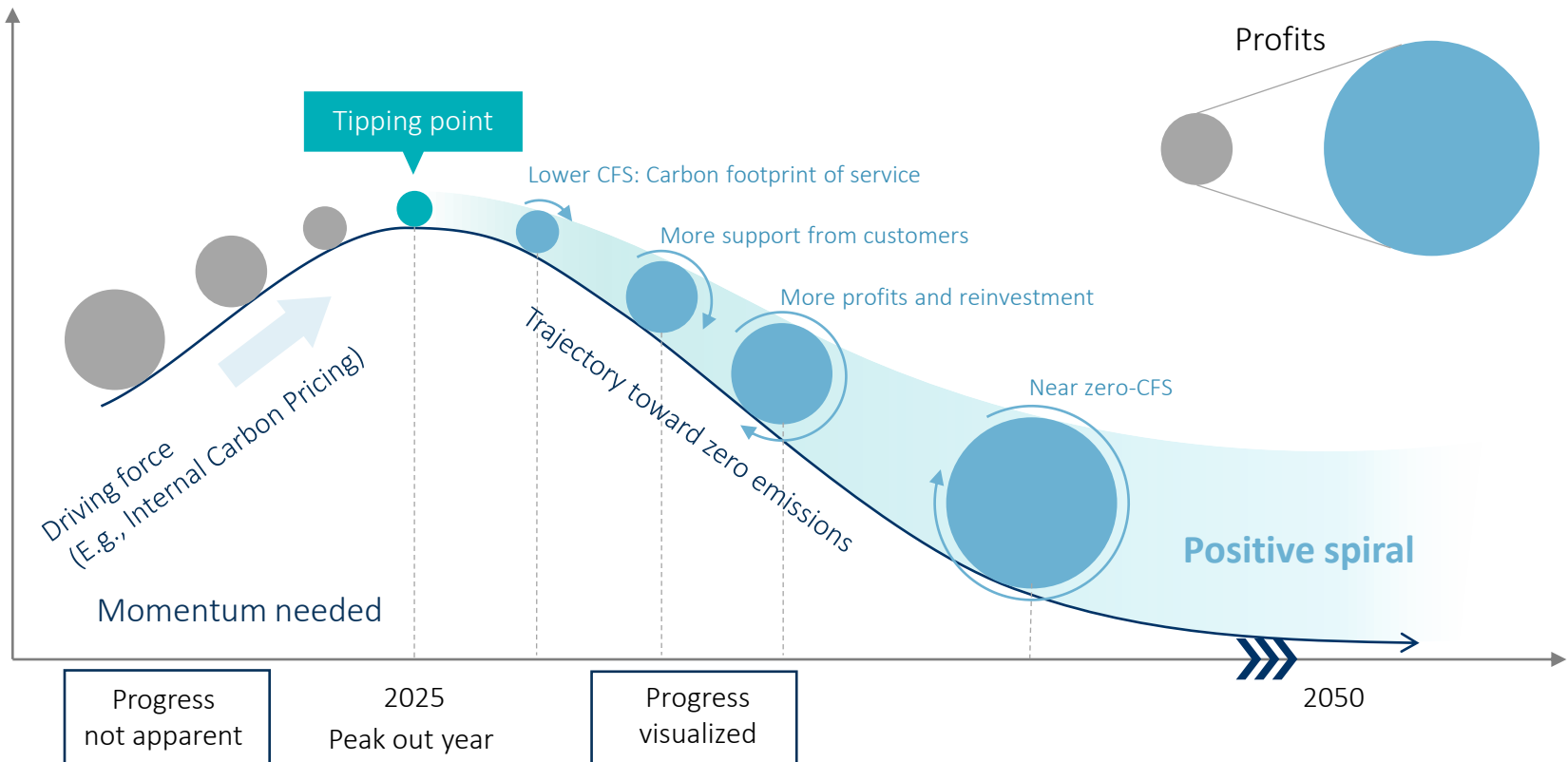

# Sustainable growth plan in the context of decarbonization

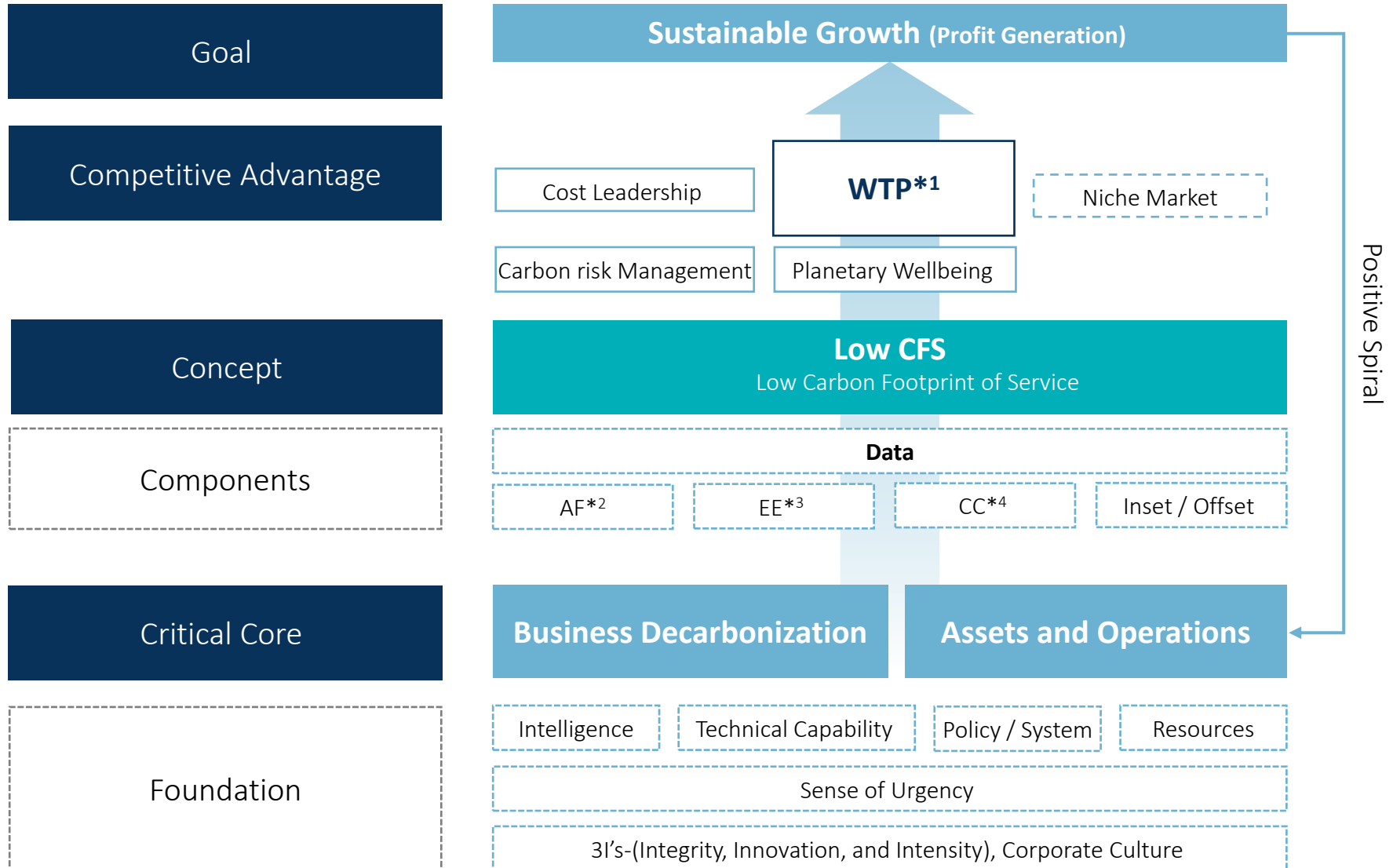

\*1 WTP: Willingness to pay \*2 AF: Alternative fuel \*3 EE: Energy efficiency \*4 CC: Carbon capture



An aerial, high-angle photograph of a large blue and white cargo ship sailing on the ocean. The ship is viewed from a distance, showing its full length and the wake it leaves behind. The text is overlaid on the image.

# *Bringing value to life.*

Our journey is to be continued.

Please look forward to the sequel of this story.



免責事項  
本資料は、電子的または機械的な方法を問わず、当社の書面による承諾を得ることなく複製又は頒布等を行わないようお願いします。

Legal Disclaimer

No part of this document shall be reproduced, stored in a retrieval system or transmitted in any form or by any means, electronic, mechanical, photocopying, recording or otherwise, without the prior written permission of NYK Line.



# Appendix

# System to manage our environmental responsibilities



- ✔ We have been ISO-certified since 2002, the first shipping company to achieve this recognition.
  - ISO 14001, internationally agreed standard that helps improve the performance through more efficient use of resources, allowing us to gain a competitive advantage and the trust of stakeholders.
  - System coverage now extends to our **66 sites** and **the fleet being operated by the NYK Group**.

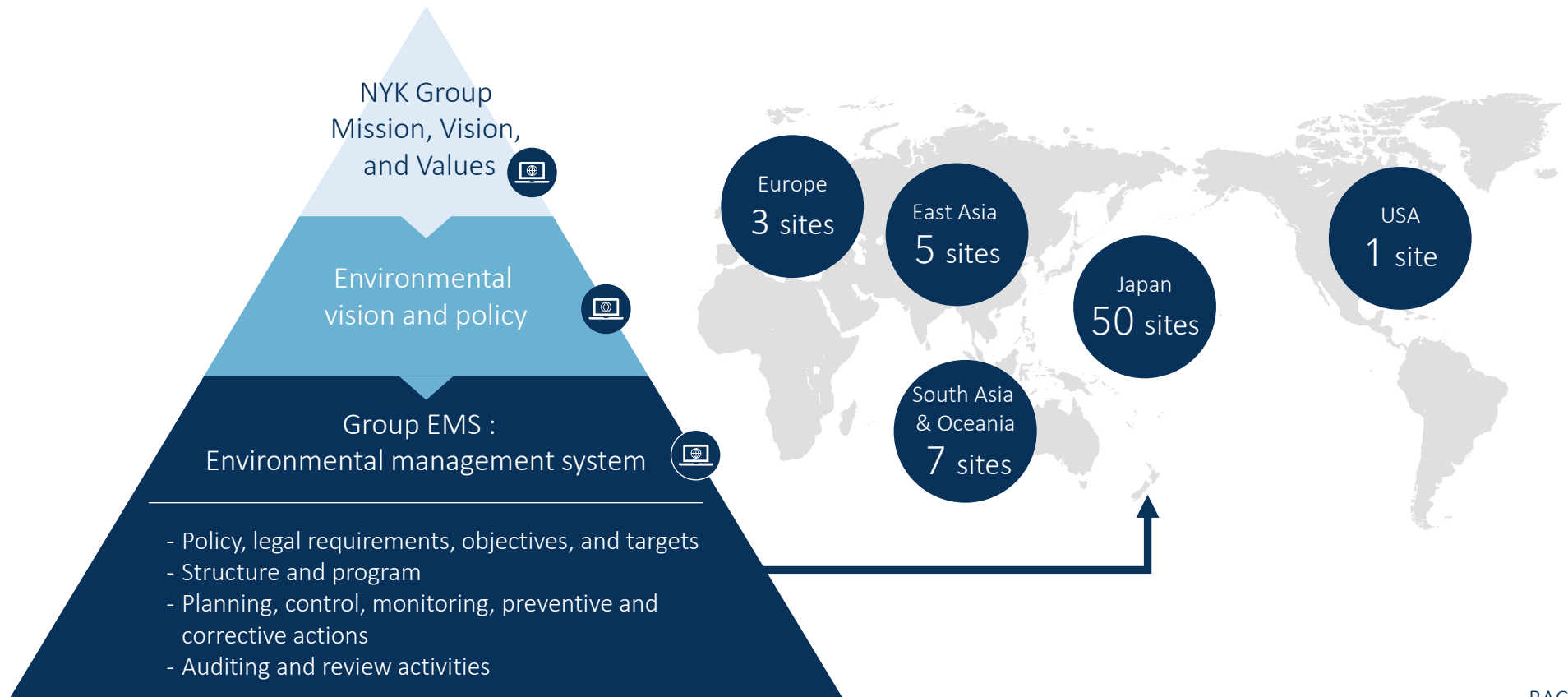

# NYK Cool Earth Project launched in 2008



- ✔ Special programs led by the strong leadership of top management in response to increasing concerns over environmental issues.
  - The launching of the “Earth Is Our Home” campaign, the introduction of e-learning focusing on global warming, and the establishment of an advocacy policy are some examples of said programs.

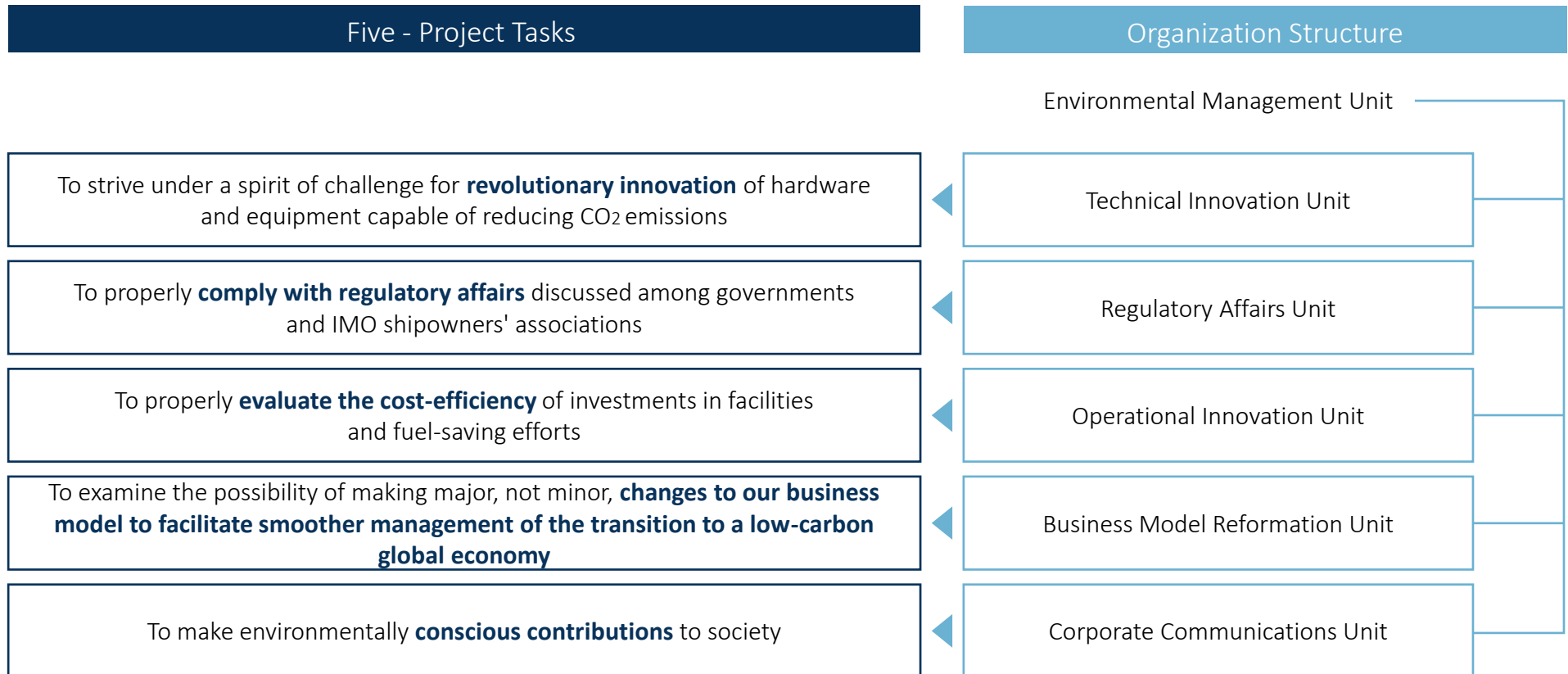

# NYK Super Eco Ship 2050



- ✓ 100% reduction in CO2 Emissions
- ✓ 67% reduction in energy derived from fossil fuels\*

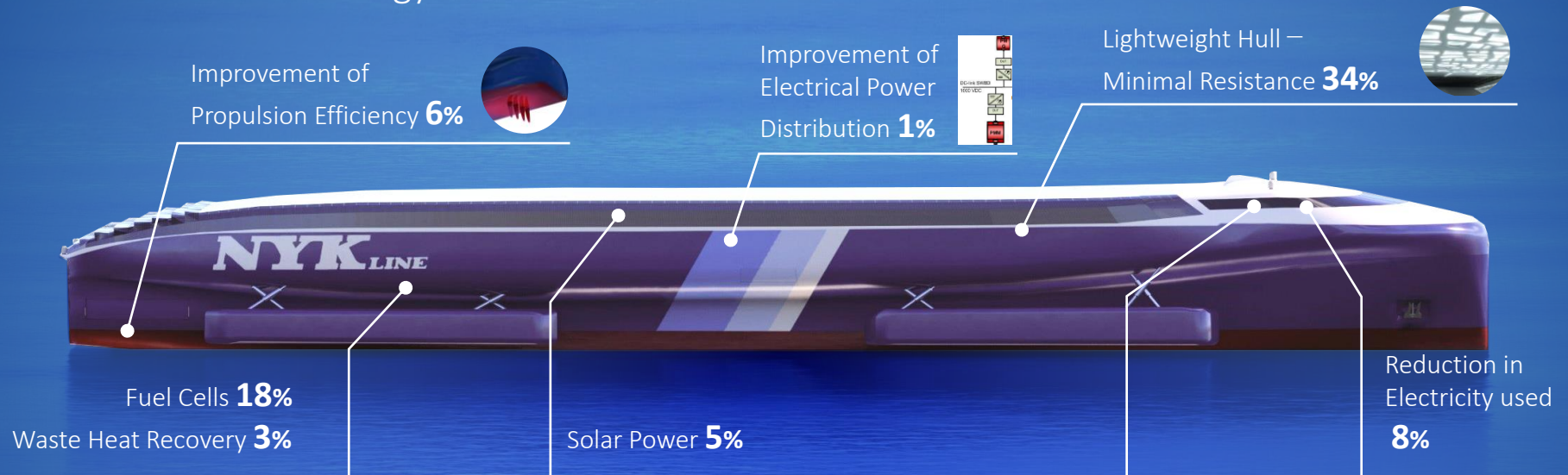

## Hydrogen Fuel Battery and Waste Heat Recovery

The vessel is powered by hydrogen fuel cells (SOFC), in which the hydrogen is produced by renewable energy sources.

- Power production efficiency: 69% through waste heat recovery
- Hydrogen tank capacity: 1,900 cubic meters/21-day endurance



## Solar Power

The storage of liquefied hydrogen on board the vessel will be expensive and require significant space, so fully utilizing power produced on board is essential.

- Energy conversion efficiency: 45%
- About 9,000 square meters of solar panels
- Covers 15% of total energy demand



## Digital Twin

Holistic digital twins enable access to shore-based expertise for the crew on board. Several scenarios can be evaluated to optimize planned and corrective maintenance to minimize accidents and troubles on board.

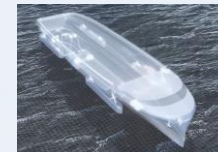

## Optimized Fleet Operation

Thanks to advanced weather and performance optimization, route planning is no longer a ship-level activity. It is done at the port and fleet level, which enables just-in-time arrival throughout the supply chain.



\* Compared with a 2014-built vessel

# Positioning of decarbonization strategy

- ✔ Achieving our decarbonization strategy requires a cross-functional approach involving all our businesses.
  - Courage, collaboration, care, and determination are key to promoting decarbonization activities.\*



\* Reference: Maersk Mc-Kinney Moller Center for Zero Carbon Shipping



# Decarbonization governing structure



- ✔ A “Center of Excellence” style structure has been adopted, which separates policy-making and business execution .
  - Each business group oversees its own emissions-reduction program for its business operations as well as for consolidated subsidiaries and equity-method affiliates. The Decarbonization Group in ESG Strategy Headquarters is responsible for the NYK Group’s decarbonization strategy, planning, and program management.

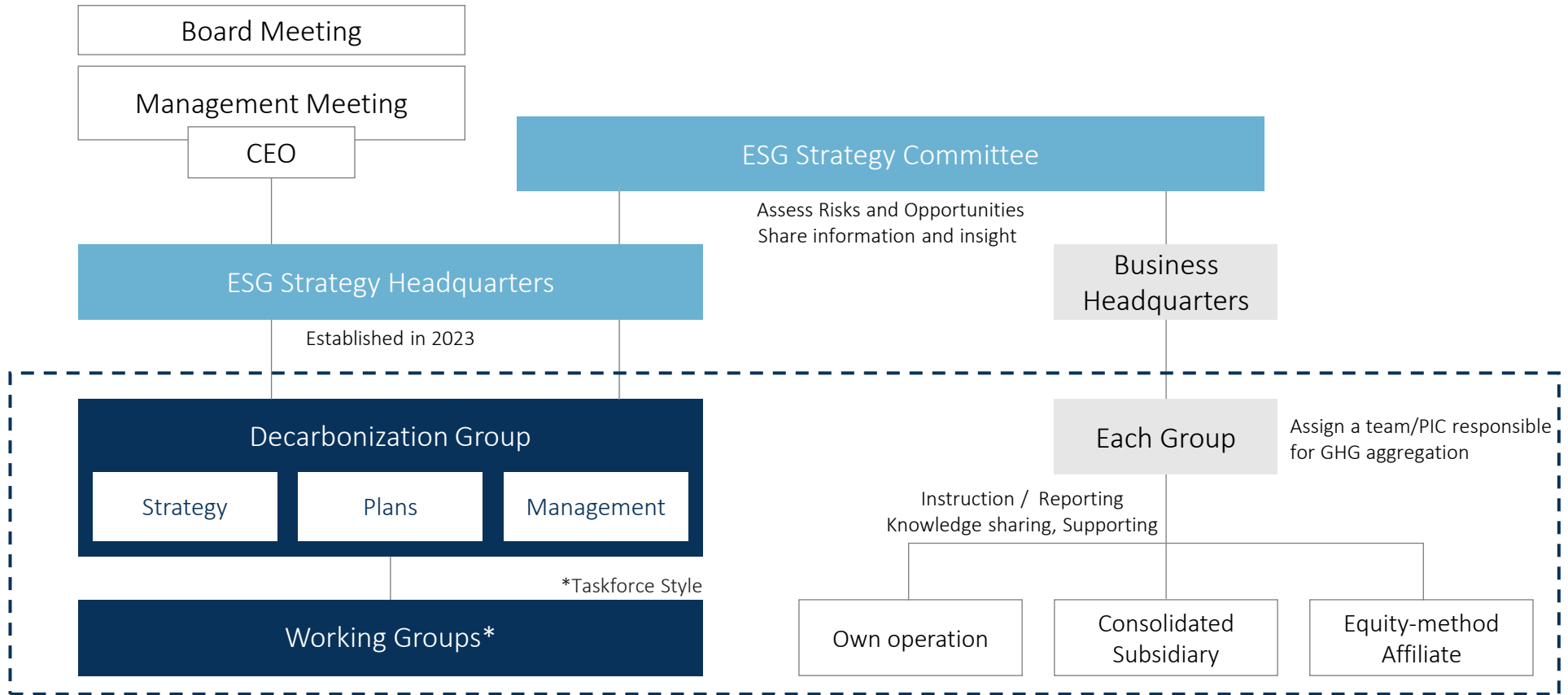



# GHG emissions from shipping – IMO 4th GHG Study



- Published in 2020, GHG emissions from the shipping segment were estimated to be about **1,000 million ton-CO<sub>2</sub>e as of 2018**.

This amount accounted for **about 3.0%** of global anthropogenic emissions.

- In 2050, about 1.5 times more emissions than the 2018 estimate are expected based on the BAU and current regulations in force (EEDI+SEEMP).

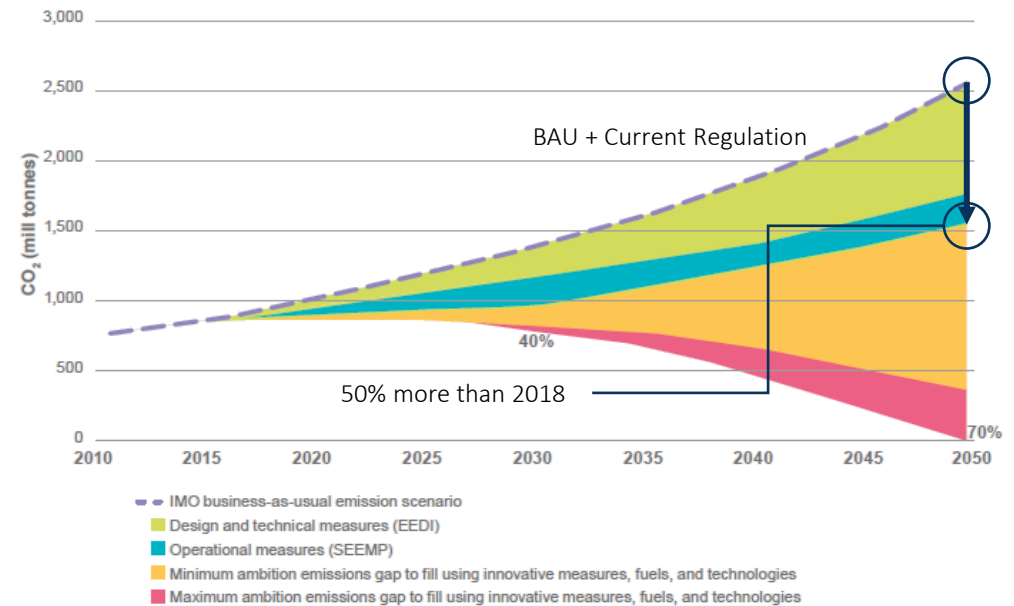
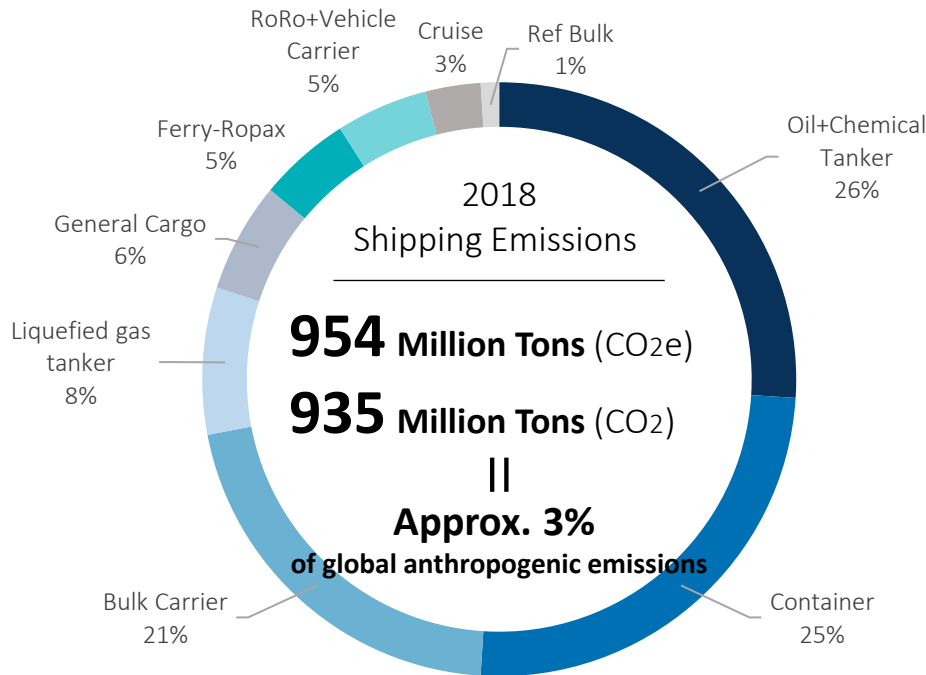

# GHG emissions from NYK Group in FY 2022



✔ The NYK Group's direct scope 1 emissions amounted to 11.3 Million ton-CO<sub>2</sub>e in 2022

- 11% reduction from the base year of 2021.

Annual GHG Emissions [ton-CO<sub>2</sub>e/Year]

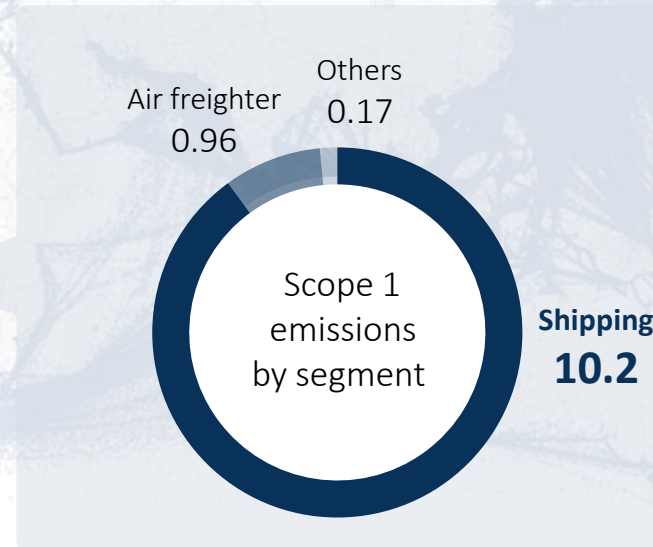
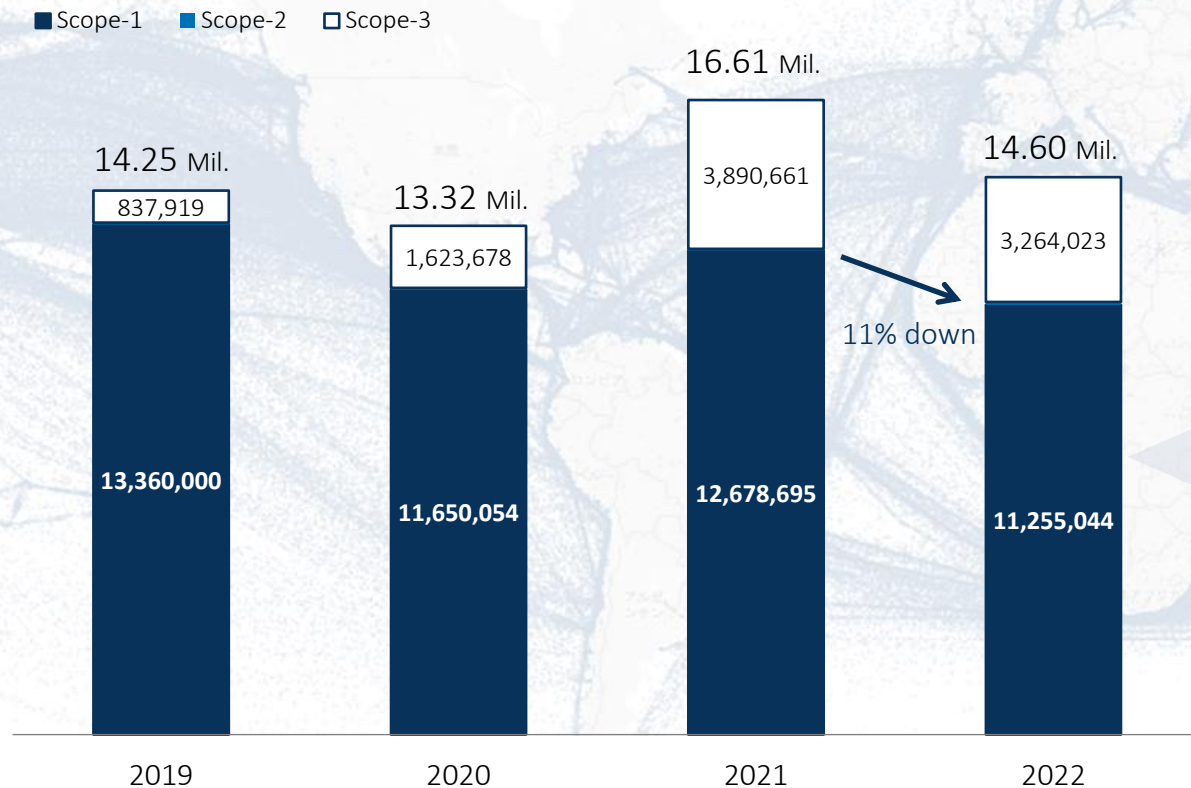

- ✔ To take appropriate actions and build solutions, we must **first to understand** the climate agenda, that we are currently facing.
  - In 2023, a series of “Climate Fresk” workshops was arranged for persons in charge of GHG emission data aggregation in each group.
  - Other than the above, a training program (e-learning), workshop and opportunities to learn about importance of climate action have been provided to build a sense of urgency on climate change.



The facts in Climate Fresk are sourced from the most respected scientific publications: the IPCC reports. These are the same reports that inform global political and economic decision-making at the highest level. Climate Fresk is neutral and objective and presents only established scientific facts.

Code Advisory Climate Fresk



# The NYK Group's GHG emissions data aggregation (1/3)



✔ The first step is to aggregate GHG data from all assets and operations of the NYK Group.

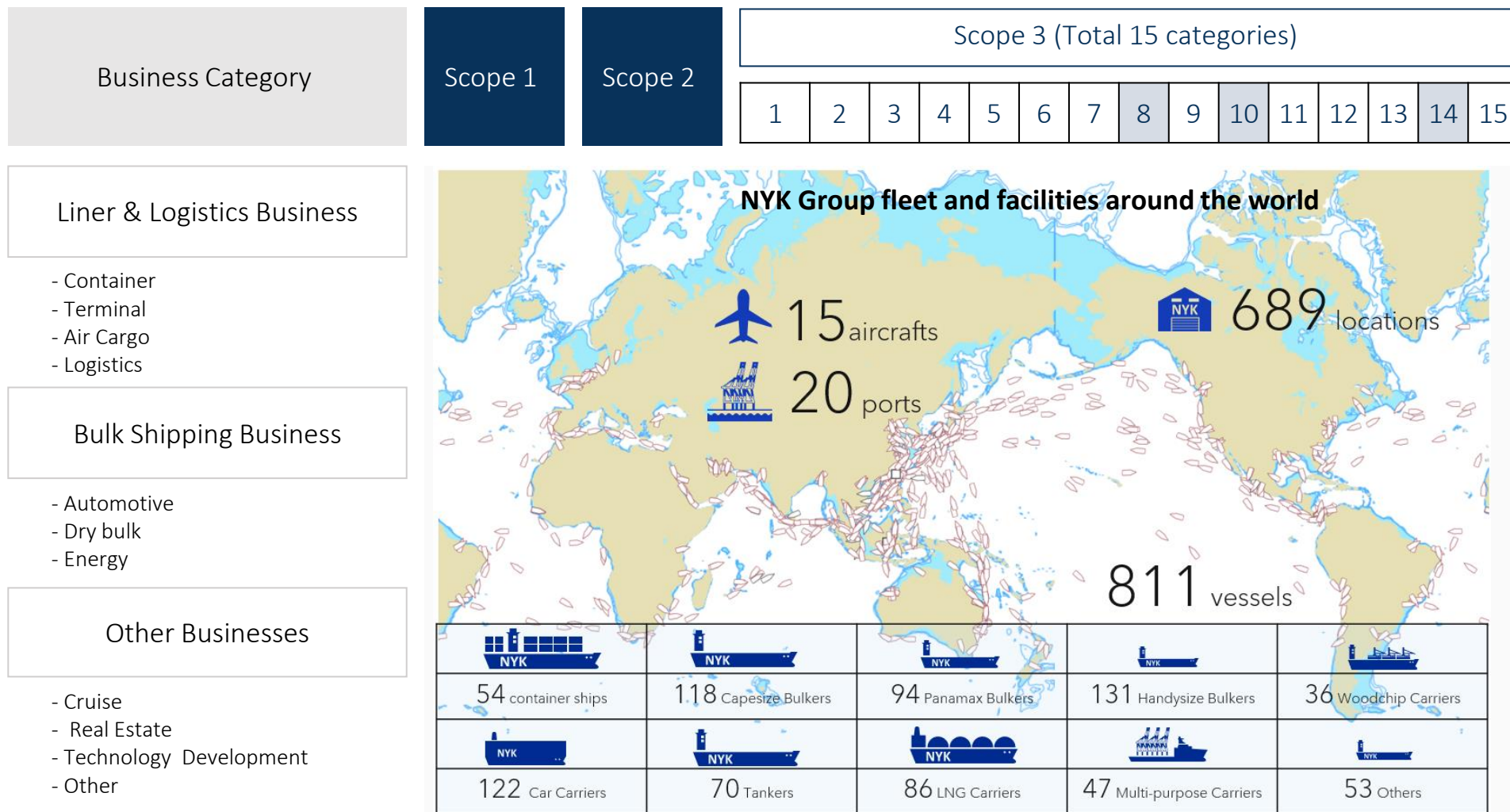

Figures as of March 31, 2023

# The NYK Group's GHG emissions data aggregation (2/3)



- ✔ A project has been established to enhance the aggregation of GHG emissions data across all scopes and all the NYK Group businesses.

[Task-1] GHG data ownership to be transferred to each business division and headquarters to enable them to utilize GHG data in ways tailored to their respective businesses

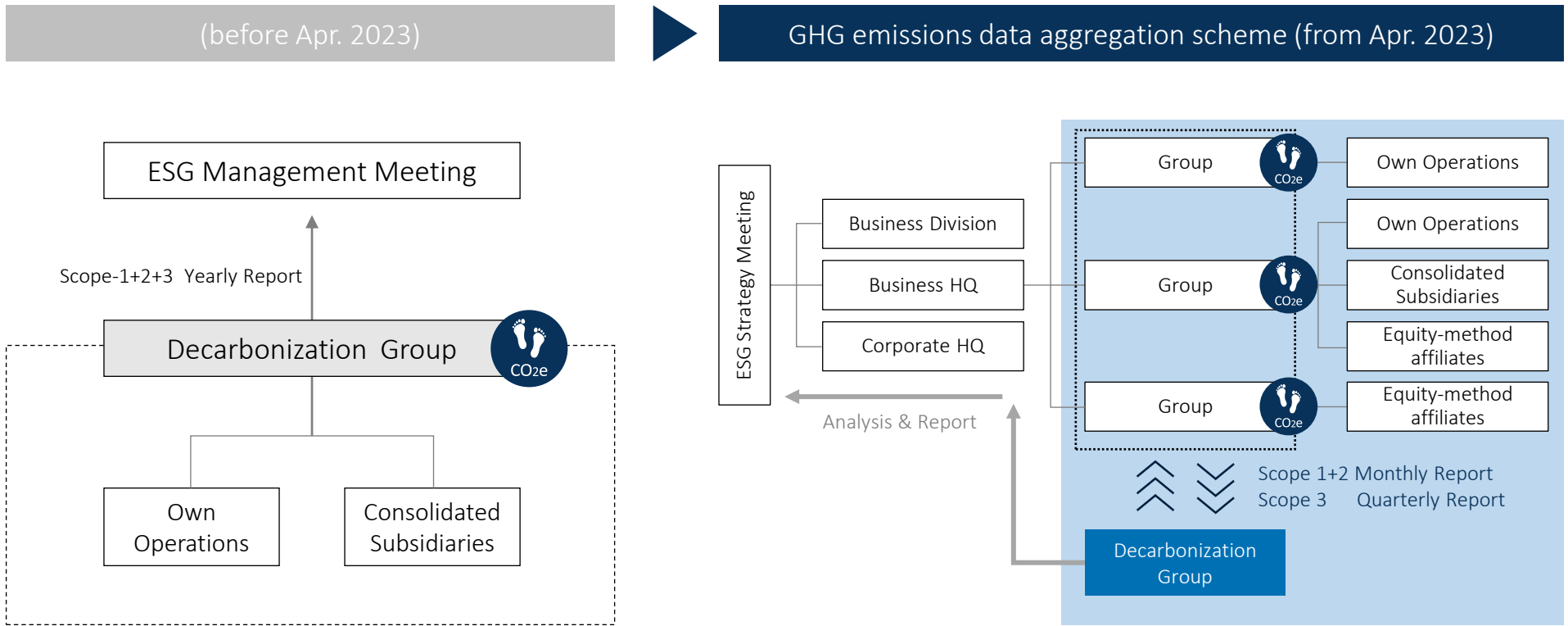

# The NYK Group's GHG emissions data aggregation (3/3)



- ✔ A project has been established to enhance the aggregation of GHG emission data across all scopes and all the NYK Group businesses.

[Task-2] GHG Scope 3 emissions data to be aggregated across all NYK Group

It seems to be a simple but complicated task ahead of us. Putting in a range of NYK Group businesses, a well-structured system and providing dedicated support to those responsible for carbon accounting across not only a range of NYK Line businesses but also the entire Group are important. For this reason, NYK appointed a consultancy service to promote the NYK Group's efforts.

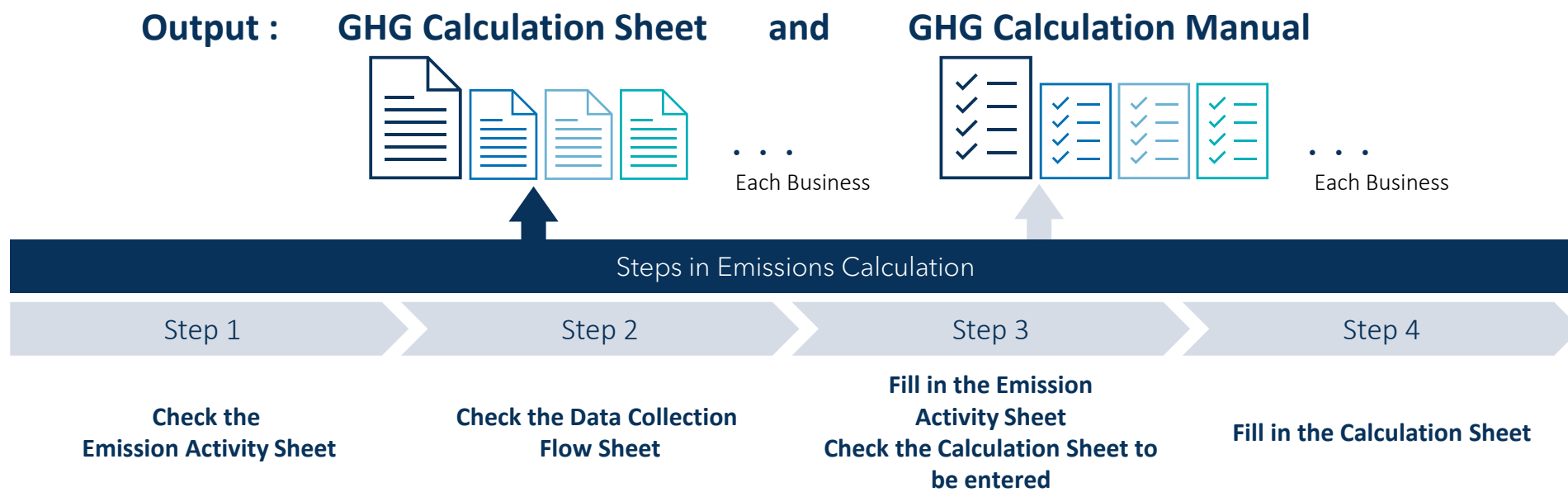

By checking the category to be calculated, the data required for calculation, and the logic to be used we can grasp an outline of the emissions calculations.

The data required for emissions calculations. The method required for gathering data, and the order of data input are to be checked. Thereafter, consideration must be given to the data that can be obtained.

For the obtainable data checked in steps 1 and 2, enter the calculation target and confirm the data to be written on the calculation sheet in step 4.

Fill the calculation sheet with the collected data.

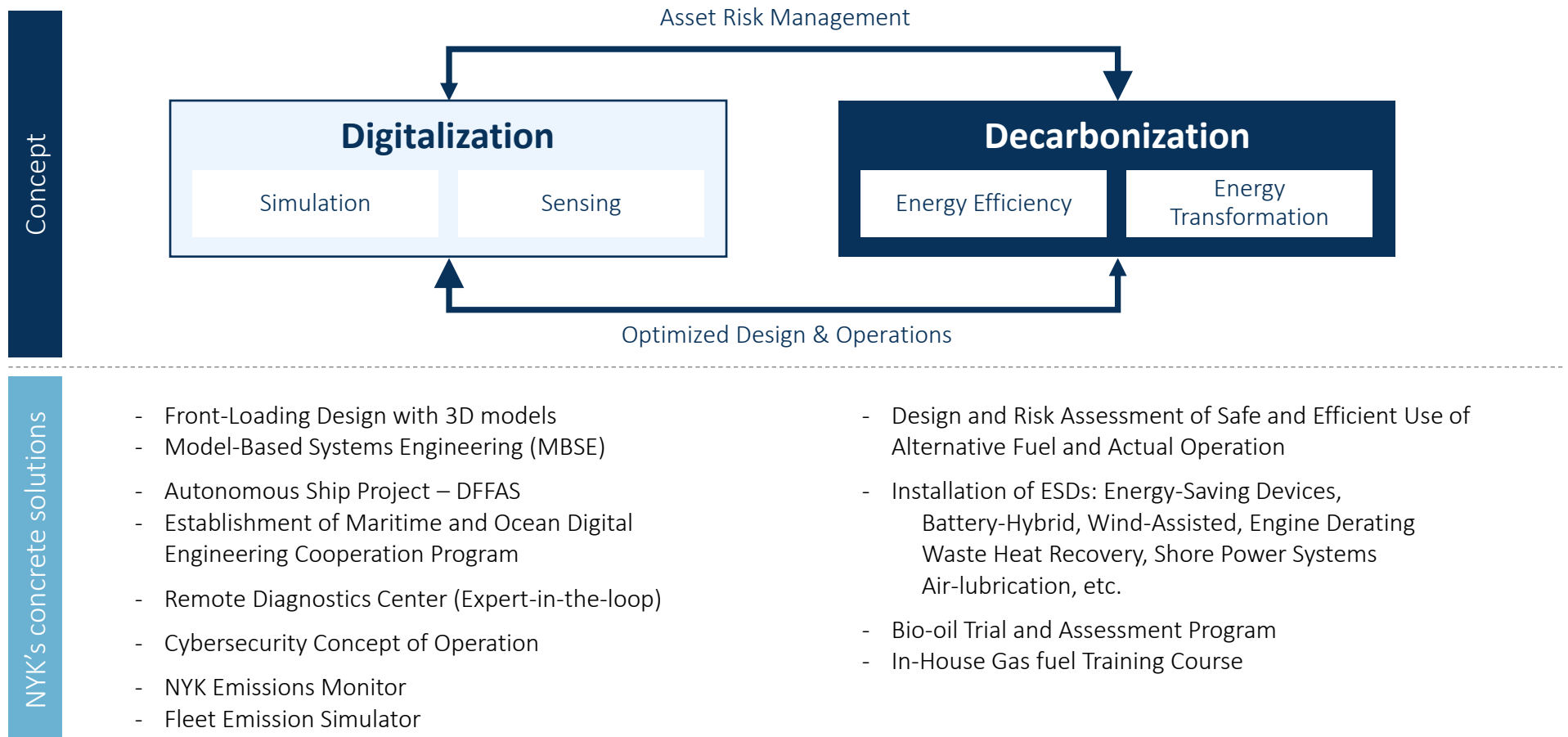

# Technology trends in the context of decarbonization

- ✔ Driving digital and energy transformation induces innovation toward carbon neutrality.
  - Cyber-physical systems will enhance safety and energy risk management and optimize design and operations.



# Identified solutions and our actions



Shell's Solutions Identified	Our action (Business resource allocation)
Scale Up Customer Demand	Emphasizing the importance of reduction throughout the supply chain of a product (E.g., Use of green Steel for newbuilding <a href="https://nbpc.co.jp/news/4062">https://nbpc.co.jp/news/4062</a> ) 
Global Regulatory Alignment	Creating a level playing field globally through involvement in industrial groups, advisory body of Japanese government for IMO agenda and various initiatives. Examples of our initiatives at <a href="https://www.nyk.com/english/esg/concept/initiatives/">https://www.nyk.com/english/esg/concept/initiatives/</a> 
Cross-sector Research and Development	Intensifying partnerships through participation in Maersk Mc-Kinney Moller Center for Zero Carbon Shipping, Global Maritime Forum, and Global Center for Maritime Decarbonization, among others to come.
Scale up Controlled Pilot Projects	Launching small scale NH <sub>3</sub> fueled pilot project for a Tug and applying the lessons learned to the large-scale projects as NYK did for the application of LNG as fuel.
Coordinated industry commitments	Increasing the reach of existing initiatives to be in line with our policies.
Flexible and Modular Design	Leading the dual-fueled concept design applicable to various types of vessels.
Port Coalitions	Actively participated in Green Shipping Corridor Projects.
Investor Pressure	Increasing the depth of engagement with stakeholders over climate agenda.
Green Finance	Use of green-related loans such as green bond (2018) / transition bond (2023)
Scale-up Fuel Production	Joined forces to help decarbonize hard-to-abate sectors (2021) Invested in Tsubame BHP for producing NH <sub>3</sub> with less energy (2021)
Scale-up Bunkering Infrastructure	LNG bunkering business
Operational Efficiency	Fleet upkeep project ongoing across the shipping businesses. Continuous efforts to improve operational efficiency





# Path planning – Risks and opportunities

✔ The first report (TCFD Report) was published in 2022 and widely covers NYK’s business through a qualitative assessment to evaluate the financial impact of climate change. The report’s coverage has now been extended to encompass a quantitative approach to evaluate the physical risks on specific businesses vulnerable to the threat of climate change.

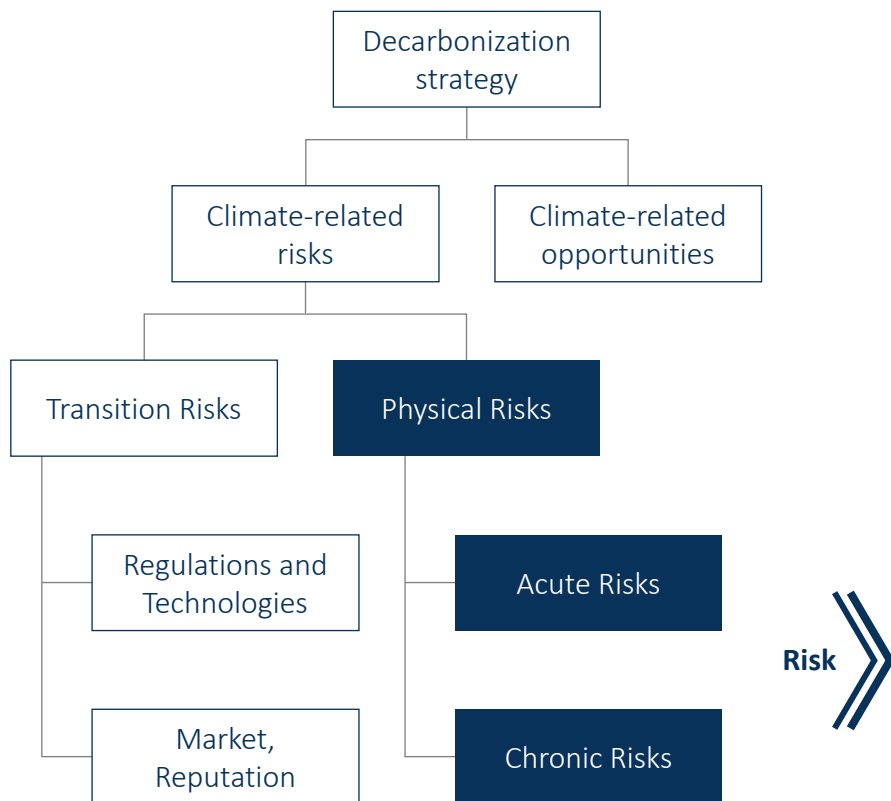

## Assets and Operations



## Quantitative Risk Assessment (2023)

- 1 Physical risk and supply chain risk assessment for logistics bases on shore
- 2 Physical risk and opportunity assessment for oceangoing vessels at sea



# Risk and opportunity – Quantitative assessment (on shore)

- ☑ The modeling and conditioning of climate change risk assessments regarding onshore assets is performed.

## Wind risk assessment model

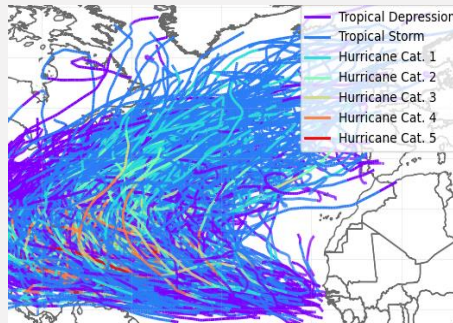

Evaluates wind risk of tropical cyclones (TCs) based on past meteorological data

## Flood risk assessment model



Evaluates flood risk based on published flood inundation maps

## Risk calculation under the future climate

Incorporates future changes in TCs and floods utilizing literature and various climate change projection data.

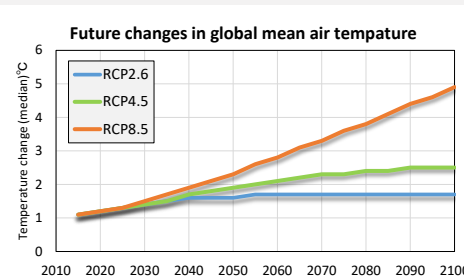

### Considered future changes

- Changes in TC frequency and intensity
- Changes in severe rainfall frequency and intensity
- Sea-level rise

## Risk calculation under the present climate

## Climate change risk assessments

### Output:

- \$ XX increase in asset depreciation until 2050.
- YoY decrease of YY % in operating rate until 2050.

### Loss (JPY)

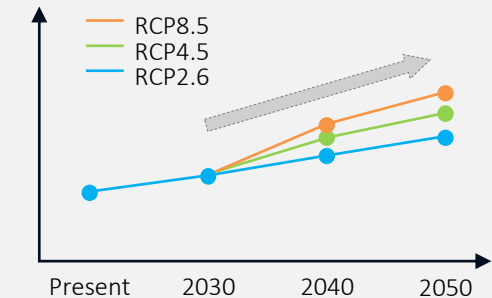

### Operating rate (%)

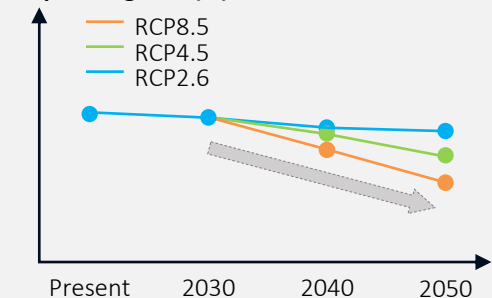

# Risks and opportunities – Quantitative assessment (at sea)

## Physical risk and opportunity assessment for **oceangoing vessels at sea**

- **Question:** How severely will the shipping activity be impacted by the future climate ?
- **Our View:** An increase in physical risks such as asset integrity, cargo damage, fuel consumption, GHG emissions due to the maritime weather in the future climate is not anticipated in this study but will review further.

Location-based Sea State

North Pacific

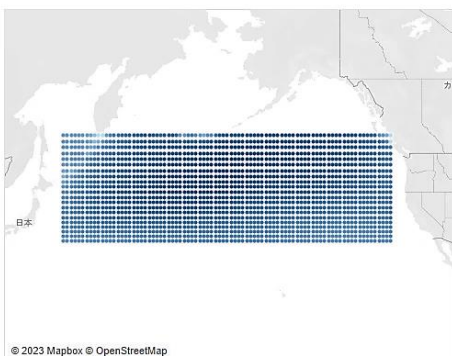

Encountered Sea State

North Pacific (Position Record)

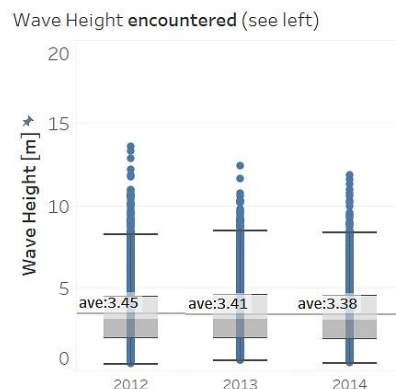
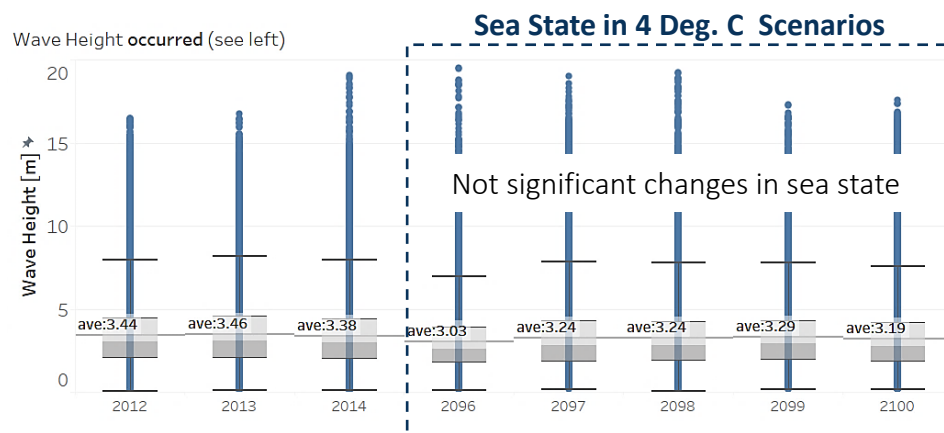
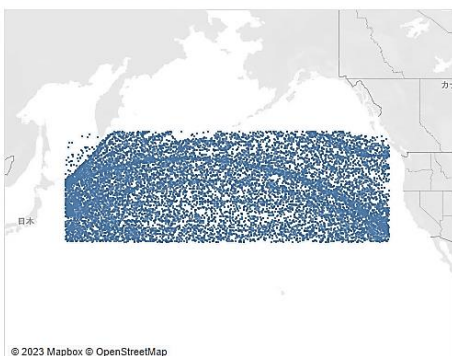

If the sea state at each location does not deteriorate in the future climate, then the encountered sea state will remain unaffected (see year 2096 – 2100).

**No significant changes in encountered sea state**



# Path Planning – Setting targets (comparison with past targets)



✔ Aligned to the IPCC 1.5 deg. C scenario shows the resolute determination.

Before					▶	New
<b>Announcement of Net-Zero Emissions</b>					Long-Term	<b>GHG Reduction Target (2023)</b>
Released	Sep. 30, 2021					November 2023
Target Year	2050					2050
Objective	Net-Zero Emissions					(Re-defined) Net-Zero Emission
Scope	Oceangoing Businesses					<b>GHG Scope-1/2/3 Across all NYK Group Businesses</b>
					Mid-Term	<b>GHG Reduction Target (2023)</b>
						November 2023
						NYK Group ESG Story 2023 (NYK Group Decarbonization Story)
						Base Year 2021
						<b>Target Year 2030</b>
						Unit: Absolute GHG Emission
						<b>Reduction 45% GHG Scope 1 + 2 (Indicative Checkpoints) 60% / 2035, 70% / 2040</b>
		History			Latest Management Plan	
Released	2008	2011	2014	2018	March 2023	
Medium-term Management Plan	New Horizon 2010	More Than Shipping 2013	More Than Shipping 2018	Staying Ahead 2022	Sail Green, Drive Transformation 2026	
Base Year	2006	2010	2010	2015	2021	
Target Year	2013	2015	2018	2030	2030	
Unit	Efficiency	Efficiency	Efficiency	Efficiency	Absolute	
Target Reduction	10%	10%	15%	30%	30% - (Int'l Shipping) - 10% (Other)	
Result	-	▲13.4% (2015)	▲14.3% (2017)	+6.4% (2021)		

BACK

# Path Planning – Updating the target (Medium-term management plan)



- ✔ We shall reduce GHG emissions by a further 15% beyond our reference in the latest medium-term management plan by improving energy efficiency under ICP scheme and using low-carbon fuels such as bio-oils.

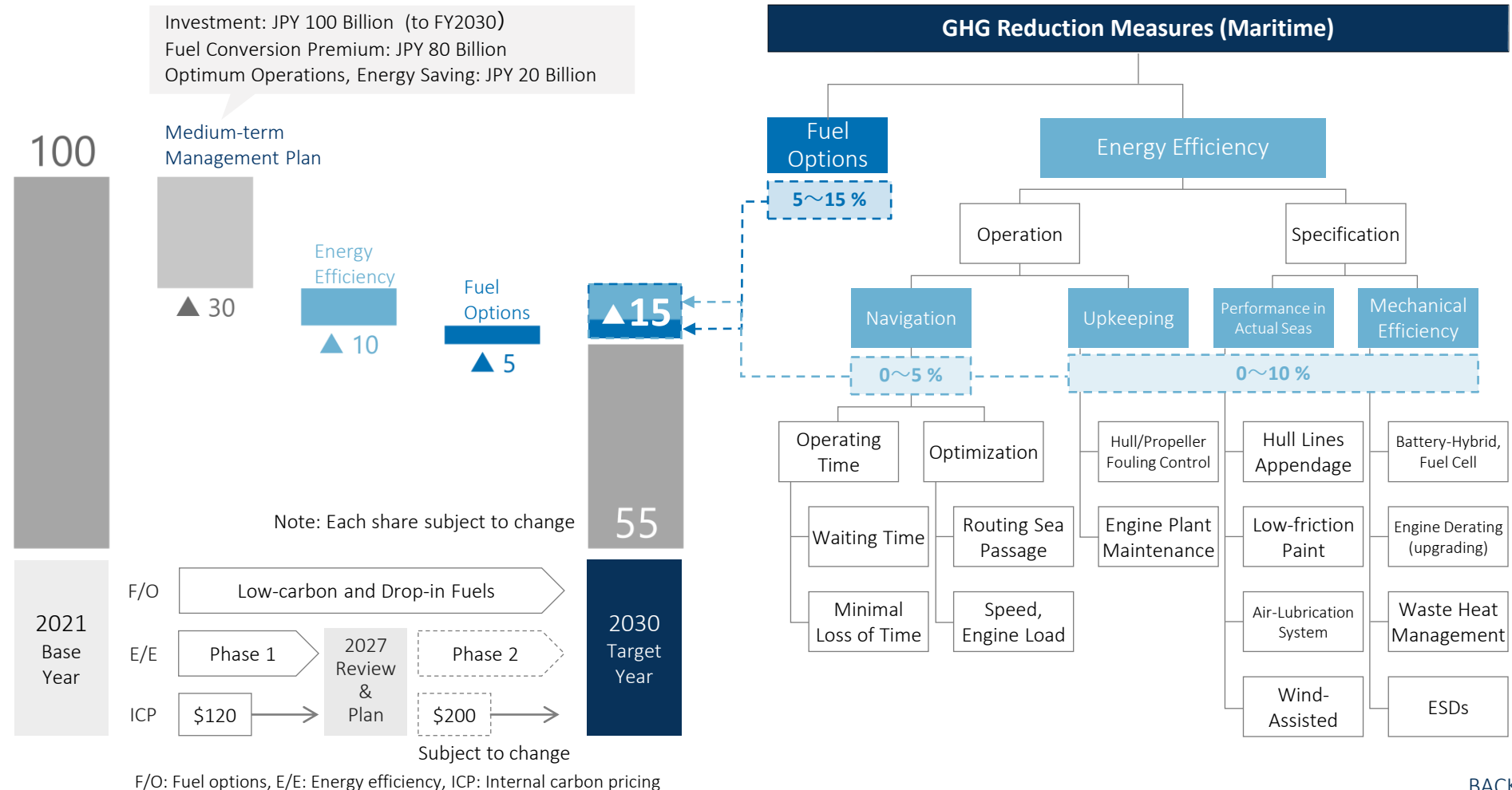

# Comparison of IMO and NYK GHG reduction targets



✔ In 2023 IMO strategy on reduction of GHG Emissions from Ships was adopted in MEPC-80

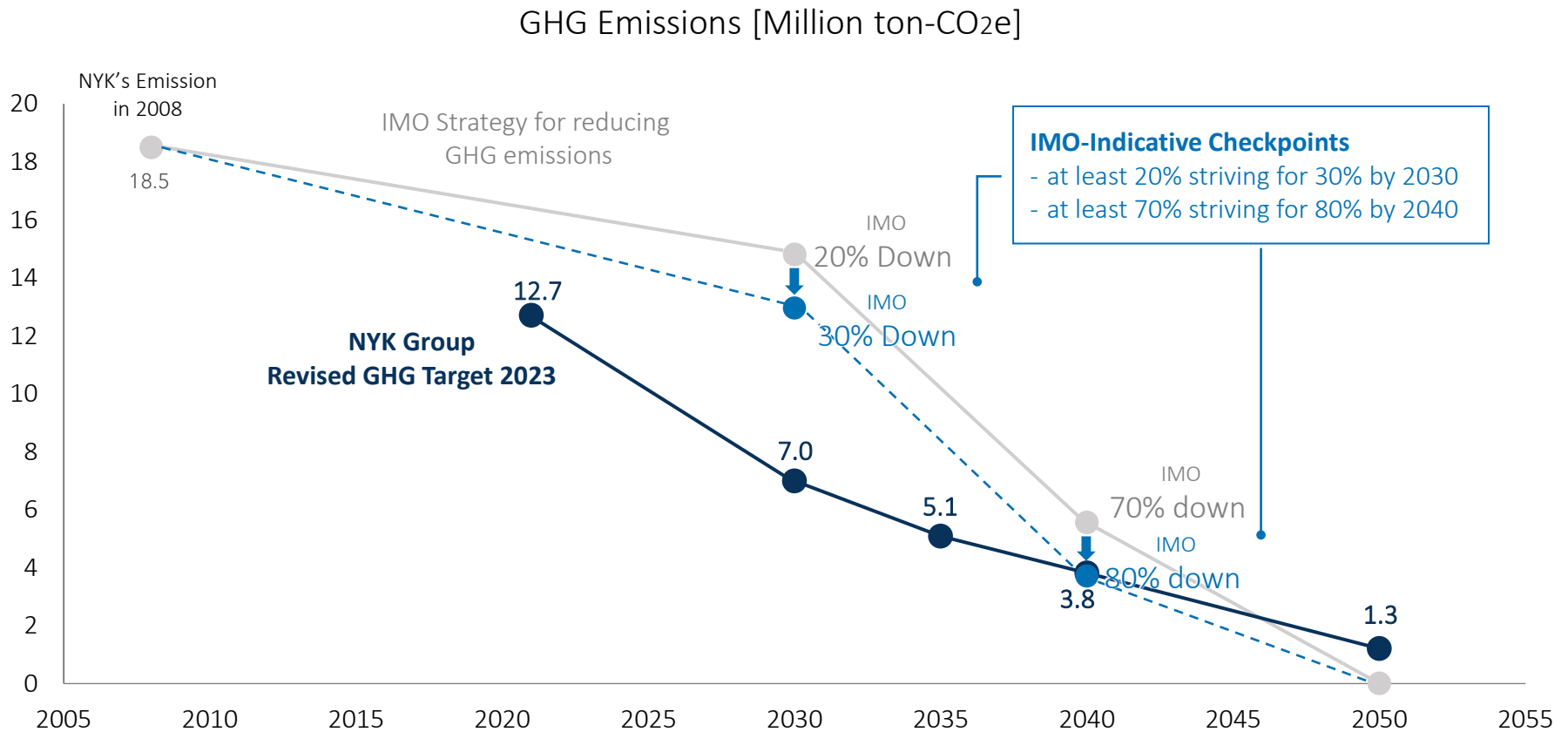

# Zero Pathfinder – an integrated simulation system



✔ **The Zero Pathfinder system performs techno-economic-based simulations** incorporating actual performance and operational profile data to assess fuel options, GHG reduction trajectories and the total cost impact, under parameters such as operational speed, operational ratio, improvement in energy efficiency, carbon prices and future fuel prices are included.



- Use Case: 1. Scenario Study 2. Carbon Budget Setting

Corporate GHG Emissions [ton-CO<sub>2</sub>/year]

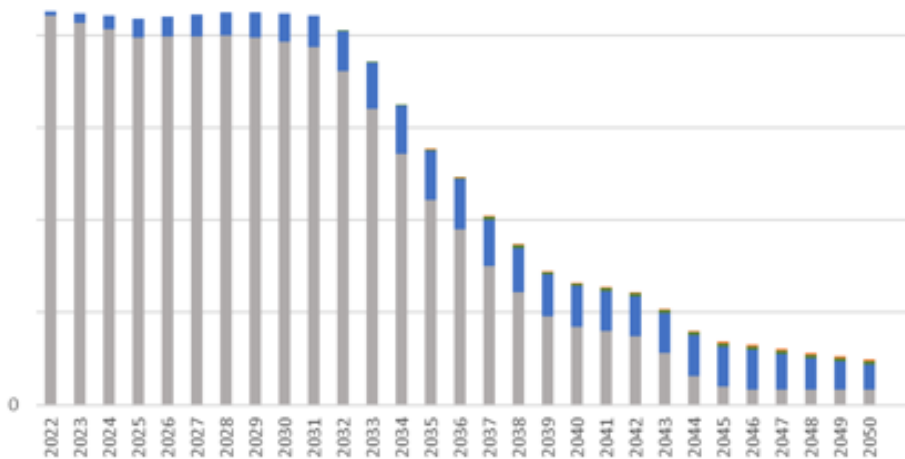

Fuel Share of NYK Fleet [%]

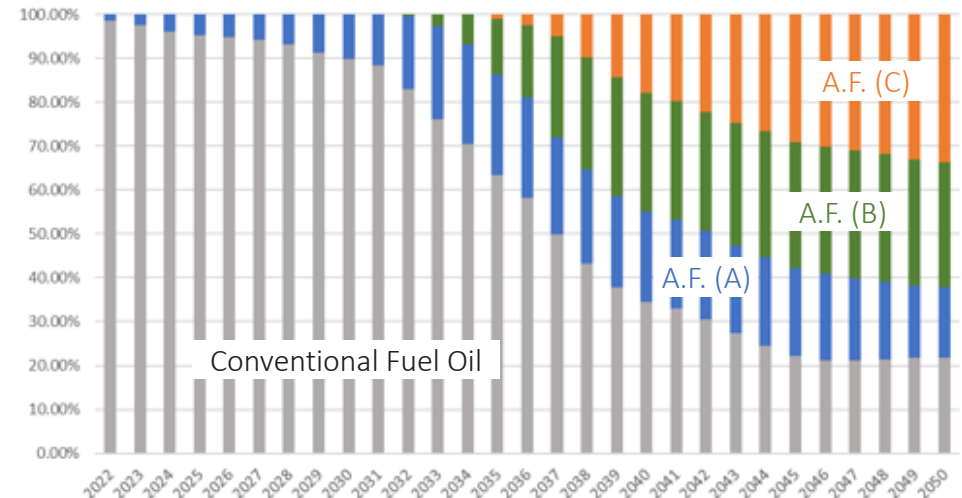

Output Examples

A.F. : Alternative fuel



# Shipping activity and energy efficiency × intensity



☑ To reduce the shipping activity for the purpose of GHG reduction is not an option.

## Shipping Activity

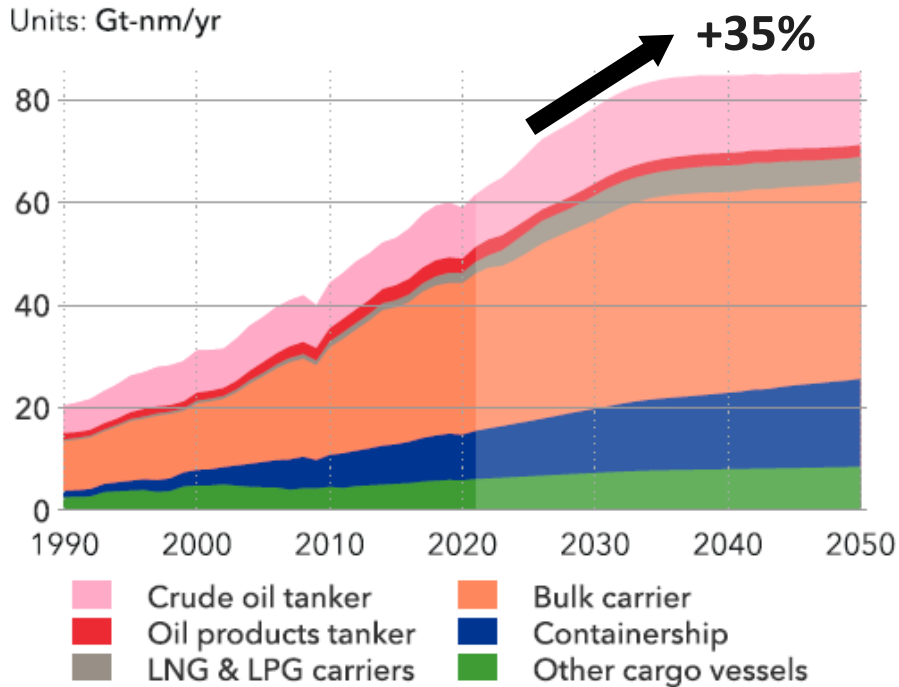

## Energy Efficiency × Intensity

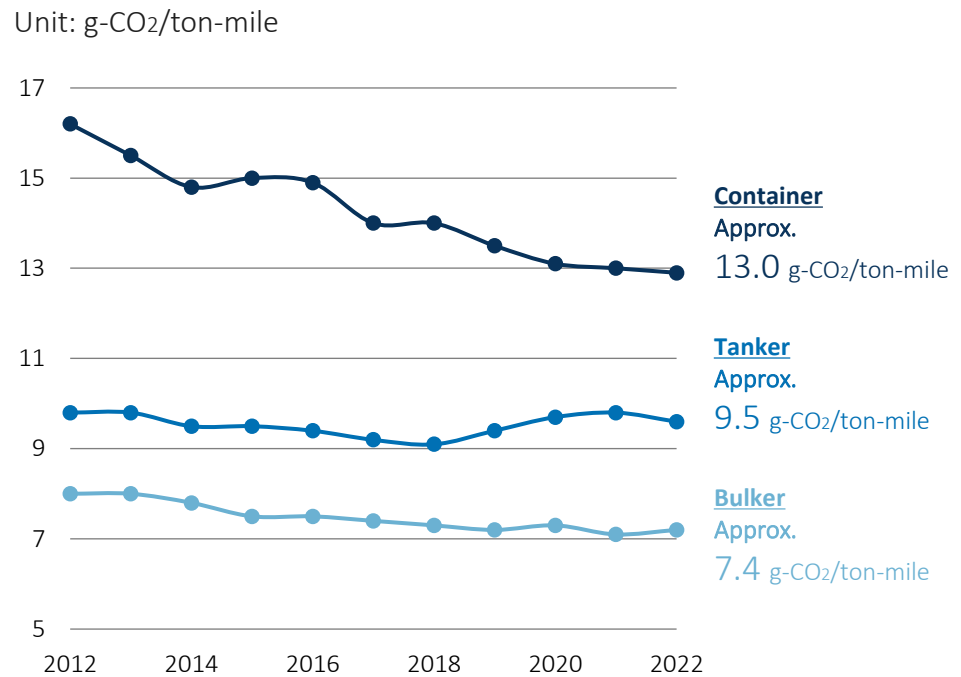

Source : DNV – “Energy Transition Outlook 2023 - Transport in transition”

Source: UNCTAD – Ship Type Energy efficiency



# LNG – NH3 pathway for tech-driven transition (1/2)

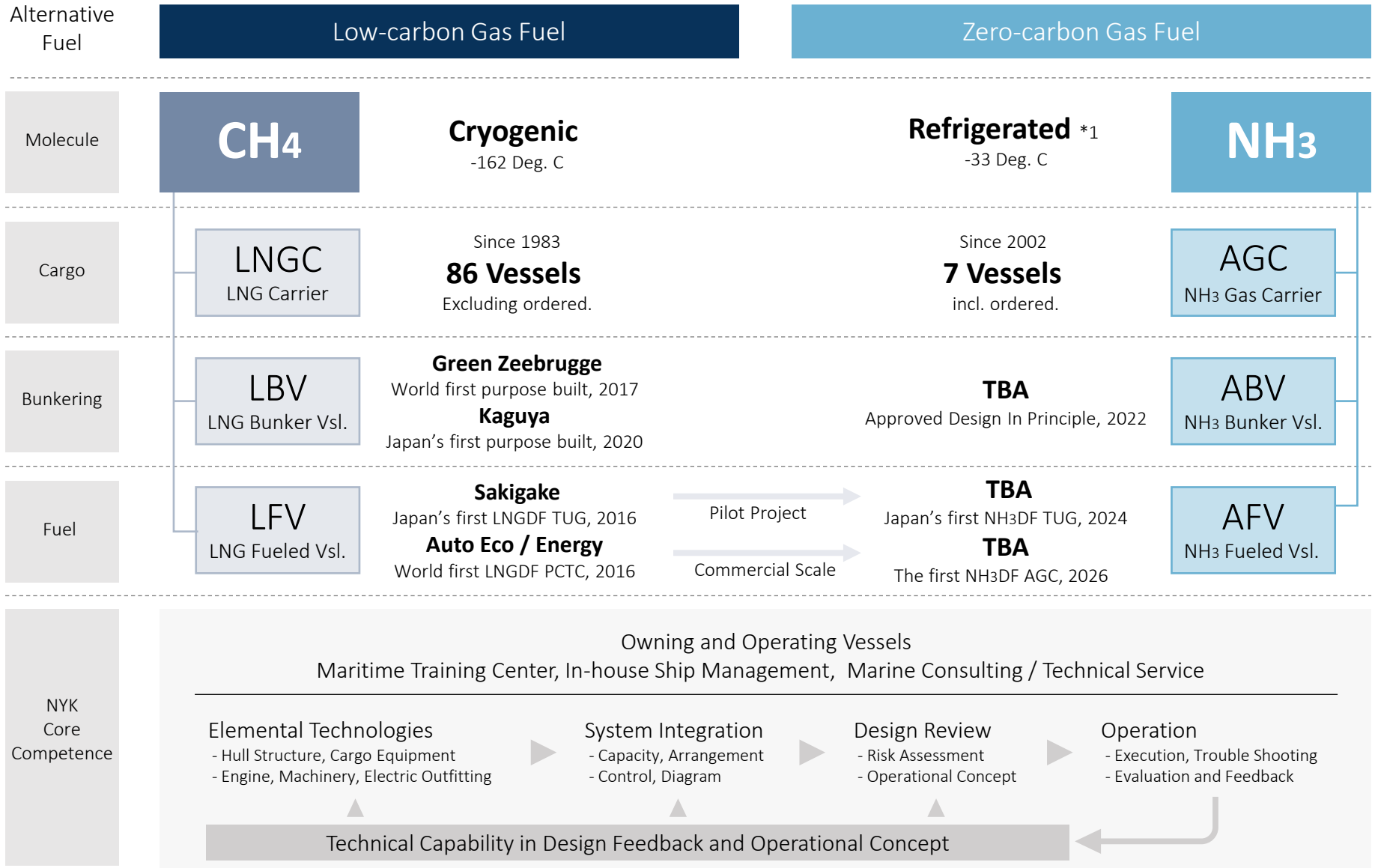

\*1: It is also possible to carry ammonia in pressurized state (at ambient temp.) or semi-refrigerated state (10-20 deg.)



# LNG – NH3 pathway for tech-driven transition (2/2)

Alternative Fuel

## Low-carbon Gas Fuel

## Zero-carbon Gas Fuel

Automation Technologies

System Integration

Sensing and Simulation

**1989 S.S. NORTHWEST SWIFT Delivered**  
Integrated Automation System(IAS) adopted

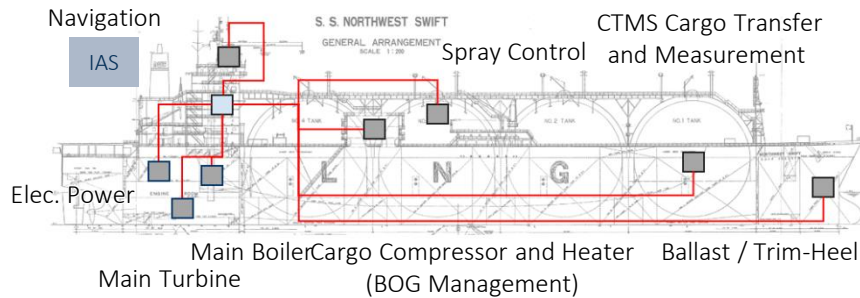

**2021 LNG FGSS\* Simulation (NYK / MTI)**  
Model-based safety assessment

[Accuracy verified by actual operational data]

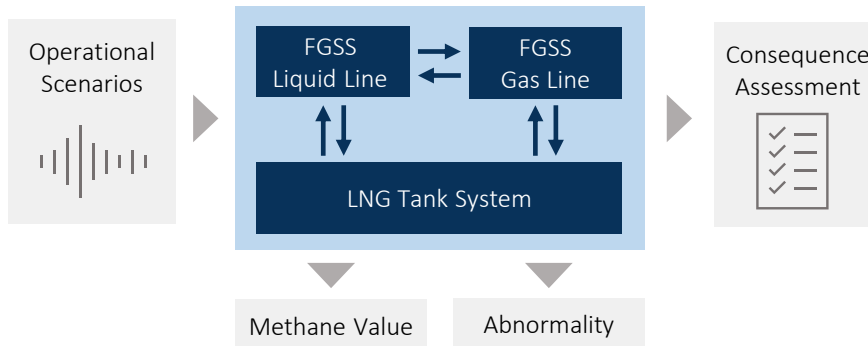

Way forward to mitigate the risk of using ammonia

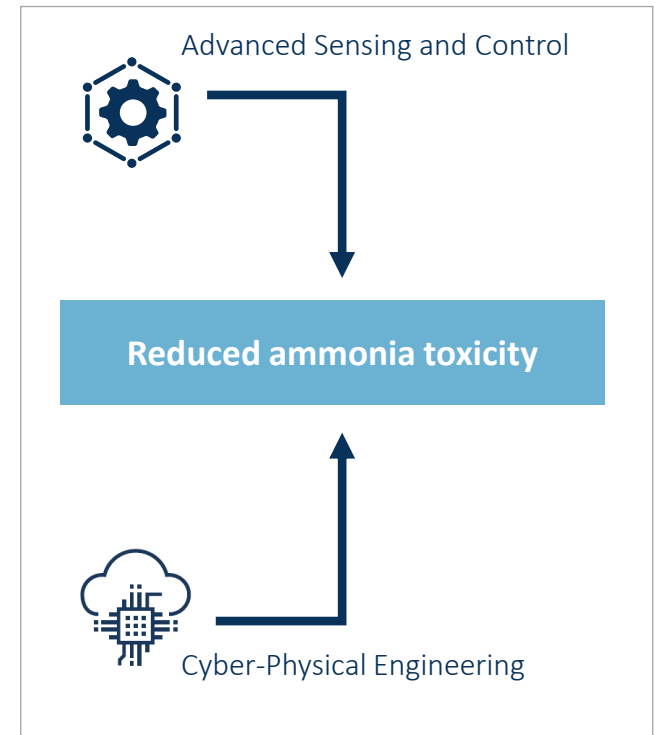

With collaborative innovation

\* FGSS: Fuel gas supply system

# NETs (Negative Emission Technologies)

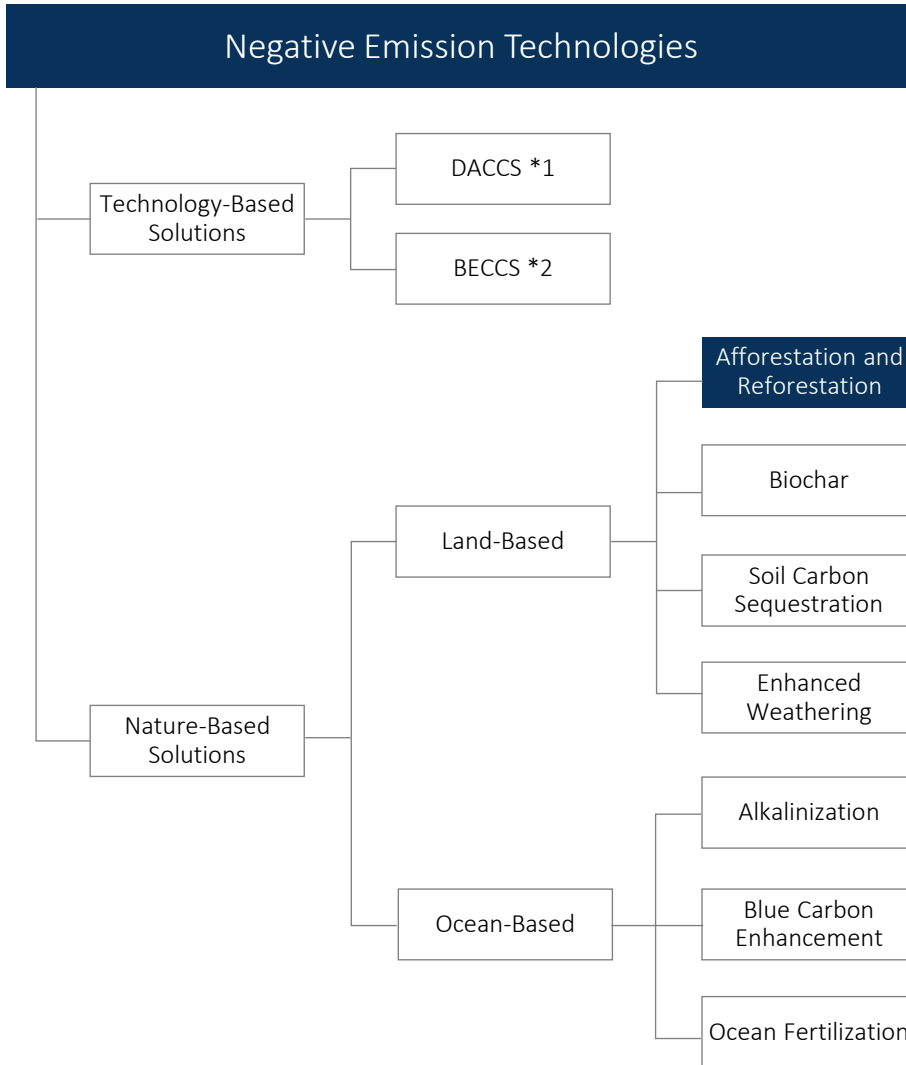

TRL*1	Abatement Cost Level*2	Mitigation Potential*3	Associated Risks
6	100 – 300	5 - 40	Increased energy and Water use
5~6	15 – 400	0.5 – 11	Additional Land and water use
8~9	0 – 240	0.5 – 10	Reversal of carbon removal
6~7	10 – 345	0.3 - 6.6	Particulate and GHG emission from production
8~9	Minus 45 – 100	0.6 - 9.3	Increased N <sub>2</sub> O emission from organic nitrogen in the soil
3~4	50 – 200	2 – 4	Air quality impacts of rock dust when spreading on soil
1~2	40 – 260	1 – 100	Marine biota. Possible release of nutritive elements
2~3	Insufficient data	< 1	Release carbon back to atmosphere.
1~2	50 - 500	1 - 3	Potential for decadal to millennial-scale return

Figure and Table : Negative Emission Technologies and the evaluation (as of 2023).

\*1: DACCS: Direct air carbon dioxide capture and storage

\*2: BECCS: Bio-energy with carbon dioxide capture and storage

\*1 TRL: Technology Readiness Level, \*2 Unit: \$/ton-CO<sub>2</sub>e \*3 Unit: Giga ton-CO<sub>2</sub>e/Year

# Stakeholders in the maritime industry

- ✔ **Collaboration** among stakeholders in the shipping ecosystem play an important role in decarbonization.

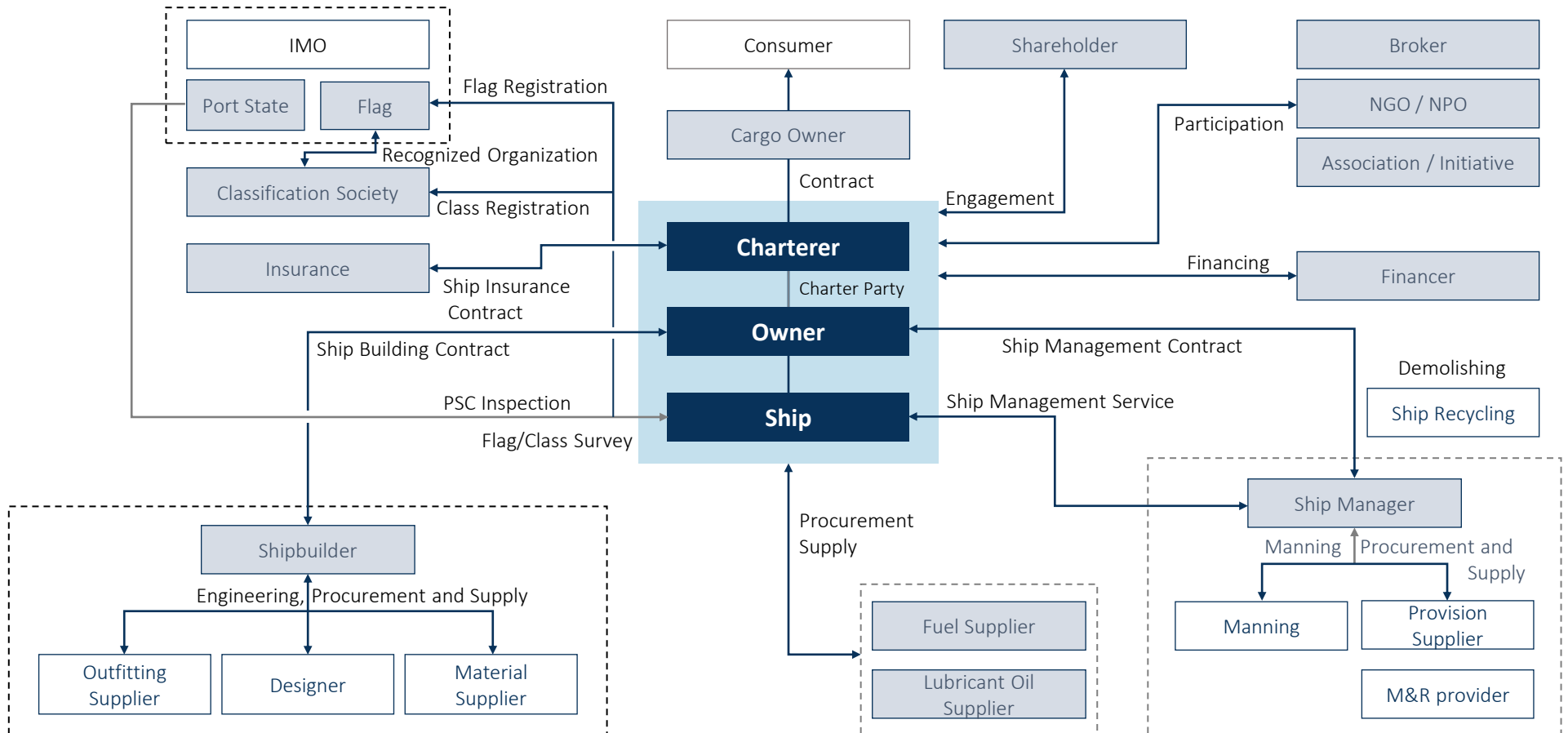

Remark: It does not cover all the stakeholders but typical for illustration